

# Keysight 2-Port and 4-Port PNA Network Analyzer

N5227A 10 MHz to 67 GHz

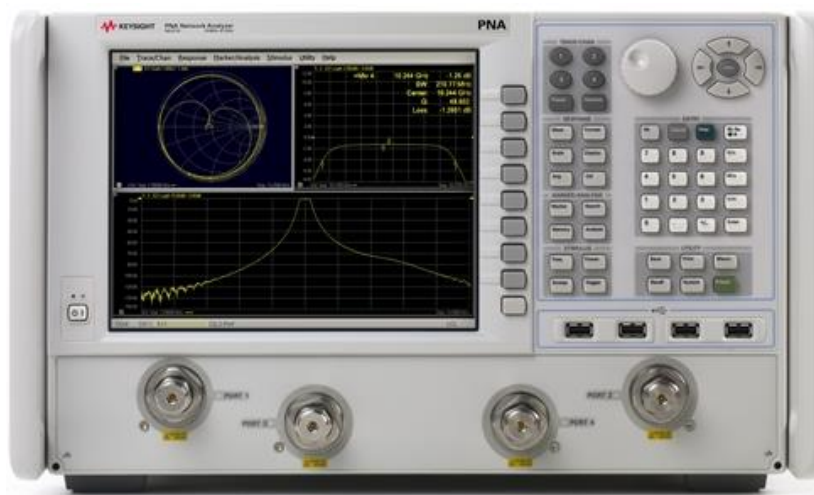

*Data Sheet and  
Technical  
Specifications*

## **Documentation Warranty**

THE MATERIAL CONTAINED IN THIS DOCUMENT IS PROVIDED "AS IS," AND IS SUBJECT TO BEING CHANGED, WITHOUT NOTICE, IN FUTURE EDITIONS. FURTHER, TO THE MAXIMUM EXTENT PERMITTED BY APPLICABLE LAW, KEYSIGHT DISCLAIMS ALL WARRANTIES, EITHER EXPRESS OR IMPLIED WITH REGARD TO THIS MANUAL AND ANY INFORMATION CONTAINED HEREIN, INCLUDING BUT NOT LIMITED TO THE IMPLIED WARRANTIES OF MERCHANTABILITY AND FITNESS FOR A PARTICULAR PURPOSE. KEYSIGHT SHALL NOT BE LIABLE FOR ERRORS OR FOR INCIDENTAL OR CONSEQUENTIAL DAMAGES IN CONNECTION WITH THE FURNISHING, USE, OR PERFORMANCE OF THIS DOCUMENT OR ANY INFORMATION CONTAINED HEREIN. SHOULD KEYSIGHT AND THE USER HAVE A SEPARATE WRITTEN AGREEMENT WITH WARRANTY TERMS COVERING THE MATERIAL IN THIS DOCUMENT THAT CONFLICT WITH THESE TERMS, THE WARRANTY TERMS IN THE SEPARATE AGREEMENT WILL CONTROL.

## **U.S. Government Rights**

*U.S. Government Rights. The Software is "commercial computer software," as defined by Federal Acquisition Regulation ("FAR") 2.101. Pursuant to FAR 12.212 and 27.405-3 and Department of Defense FAR Supplement ("DFARS") 227.7202, the U.S. government acquires commercial computer software under the same terms by which the software is customarily provided to the public. Accordingly, Keysight provides the Software to U.S. government customers under its standard commercial license, which is embodied in its End User License Agreement (EULA), a copy of which can be found at <http://www.keysight.com/find/sweula>. The license set forth in the EULA represents the exclusive authority by which the U.S. government may use, modify, distribute, or disclose the Software. The EULA and the license set forth therein, does not require or permit, among other things, that Keysight: (1) Furnish technical information related to commercial computer software or commercial computer software documentation that is not customarily provided to the public; or (2) Relinquish to, or otherwise provide, the government rights in excess of these rights customarily provided to the public to use, modify, reproduce, release, perform, display, or disclose commercial computer software or commercial computer software documentation. No additional government requirements beyond those set forth in the EULA shall apply, except to the extent that those terms, rights, or licenses are explicitly required from all providers of commercial computer software pursuant to the FAR and the DFARS and are set forth specifically in writing elsewhere in the EULA. Keysight shall be under no obligation to update, revise or otherwise modify the Software. With respect to any technical data as defined by FAR 2.101, pursuant to FAR 12.211 and 27.404.2 and DFARS 227.7102, the U.S. government acquires no greater than Limited Rights as defined in FAR 27.401 or DFAR 227.7103-5 (c), as applicable in any technical data.*

<b>Documentation Warranty</b> .....	<b>2</b>
<b>U.S. Government Rights</b> .....	<b>2</b>
Definitions.....	5
<b>Corrected System Performance</b> .....	<b>6</b>
System Dynamic Range and Receiver Dynamic Range.....	6
Table 1. System Dynamic Range and Receiver Dynamic Range, Option 200, 400.....	7
Table 2. System Dynamic Range at Test Port (dB).....	8
Table 3. Extended Dynamic Range at Direct Receiver Access Input (dB) - Specification.....	9
N5227A Corrected System Performance, All Options.....	10
Table 4a. N5227A with 85058B Calibration Kit.....	10
Table 4b. N5227A with N4694A 2-Port Electronic Calibration Module.....	12
<b>Uncorrected System Performance</b> .....	<b>14</b>
Table 5a. Error Terms (dB), All Ports, All Options - Specifications.....	14
Table 5b. Error Terms (dB), All Ports, All Options - Typical.....	15
<b>Test Port Output</b> .....	<b>16</b>
Table 6. Frequency Information, All Options.....	16
Table 7a. Maximum Leveled Power (dBm) - Specification.....	16
Table 7b. Maximum Leveled Power (dBm) - Typical.....	17
Table 8. Power Level Accuracy (dB), All Options.....	18
Table 9a. Power Level Linearity (dB), All Options - Specification.....	18
Table 9b. Power Level Linearity (dB), All Options - Specification.....	18
Table 10a. Power Sweep Range (dB) - Specification.....	19
Table 10b. Power Sweep Range (dB) - Typical.....	20
Table 11. Nominal (Preset) Power (dBm).....	20
Table 12. Power Resolution and Maximum/Minimum Settable Power, All Models and Options.....	21
Table 13. 2 <sup>nd</sup> and 3 <sup>rd</sup> Harmonics at Max Specified Power (dBc) All Options - Typical.....	21
Table 14. Non-Harmonic Spurs at Nominal Power (dBc), All Options - Typical.....	21
Table 15. Phase Noise (dBc/Hz), All Options - Typical.....	22
<b>Test Port Input</b> .....	<b>23</b>
Table 16. Test Port Noise Floor (dBm) @ 10 Hz IFBW, All Options.....	23
Table 17. Direct Receiver Access Input Noise Floor (dBm).....	24
Table 18a. 0.1 dB Receiver Compression at Test Port (dBm), Option 201, 219, 401, 419 - Typical.....	25
Table 18b. Receiver Compression at Test Port Power - Specification.....	25
Table 19. N5227A Trace Noise Magnitude (dB rms).....	26
Table 20. N5227A Trace Noise Phase (deg rms).....	26

Table 21. Reference Level Magnitude, All Models and Options - Specification .....	26
Table 22. Stability, All Options - Typical .....	27
Table 23. Damage Input Level, All Options.....	27
<b>Dynamic Accuracy.....</b>	<b>28</b>
Table 24. N5227A Dynamic Accuracy.....	28
Table 25. Group Delay - Typical.....	32
<b>General Information .....</b>	<b>33</b>
Table 26. Miscellaneous Information.....	33
Table 27. Front Panel Information, All Options.....	33
Table 28. Rear Panel Information, All Options.....	34
Table 29. Analyzer Dimensions and Weight.....	38
Regulatory and Environmental Information .....	38
<b>Measurement Throughput Summary .....</b>	<b>39</b>
Table 30. Typical Cycle Time (ms) for Measurement Completion, All Models and Options .....	39
Table 31. Typical Cycle Time (ms) for Full-Span Measurement Completion .....	40
Table 32. Cycle Time vs. IF Bandwidth - Typical.....	40
Table 33. Cycle Time vs. Number of Points - Typical.....	41
Table 34. Data Transfer Time (ms) - Typical.....	42
<b>Specifications: Front-Panel Jumpers.....</b>	<b>43</b>
Table 35. Measurement Receiver Inputs (dBm) - Typical.....	43
Table 36. Port 1 Reference Receiver Inputs and Reference Source Outputs (dBm) - Typical.....	44
Table 37. Port 2, 3, 4 Reference Receiver Inputs and Reference Source Outputs (dBm) - Typical .....	45
Table 38. Source Outputs (dBm) - Typical.....	46
Table 39. Coupler Inputs (dB) - Typical.....	47
Table 40 Damage Level, All Options - Typical .....	47
<b>Test Set Block Diagrams .....</b>	<b>48</b>
N5227A Option 200 (2-port base model).....	48
N5227A Option 201.....	48
N5227A Option 219.....	49
N5227A Option 400 (4-port base model).....	49
N5227A Option 401.....	50
N5227A Option 419.....	50
Receiver Block Diagram.....	51

*This is a complete list of the technical specifications for the N5227A PNA network analyzer with the following options. See block diagrams for all models and options beginning on page 47.*

#### **2-Port Models**

*Option 200 - 2-port base model with standard test set.*

*Option 201 - To base model, adds front-panel jumpers and R1 receiver switch.*

*Option 219 - To base model, adds front-panel jumpers, R1 receiver switch, source and receiver attenuators (extended power range), and bias-tees.*

#### **4-Port Models**

*Option 400 - 4-port base model with standard test set.*

*Option 401 - To base model, adds front-panel jumpers and R1 receiver switch.*

*Option 419 - To base model, adds front-panel jumpers, R1 receiver switch, source and receiver attenuators (extended power range), and bias-tees.*

#### **Notes**

*This document provides technical specifications for the 85058B and N4694A calibration kits.*

*Please download our free Uncertainty Calculator from [http://www.keysight.com/find/na\\_calculator](http://www.keysight.com/find/na_calculator) to generate the curves for your calibration kit and PNA setup.*

*Typical performance information between 67 GHz and 70 GHz is shown in this document where available. The performance is degraded at particular frequencies in this range due to the modes of the 1.85 mm connectors used in the analyzer, test port cables and adapters.*

*For all tables in this data sheet, the specified performance at the exact frequency of a break is the degraded value of the two specifications at that frequency.*

#### **Definitions**

*All specifications and characteristics apply over a 25 °C ±5 °C range (unless otherwise stated) and 90 minutes after the instrument has been turned on.*

**Specification (spec.):** *Warranted performance. Specifications include guardbands to account for the expected statistical performance distribution, measurement uncertainties, and changes in performance due to environmental conditions.*

**Characteristic (char.):** *A performance parameter that the product is expected to meet before it leaves the factory, but that is not verified in the field and is not covered by the product warranty. A characteristic includes the same guardbands as a specification.*

**Typical (typ.):** *Expected performance of an average unit which does not include guardbands. It is not covered by the product warranty.*

**Nominal (nom.):** *A general, descriptive term that does not imply a level of performance. It is not covered by the product warranty.*

**Calibration:** *The process of measuring known standards to characterize a network analyzer's systematic (repeatable) errors.*

**Corrected (residual):** *Indicates performance after error correction (calibration). It is determined by the quality of calibration standards and how well "known" they are, plus system repeatability, stability, and noise.*

**Uncorrected (raw):** *Indicates instrument performance without error correction. The uncorrected performance affects the stability of a calibration.*

**Standard:** *When referring to the analyzer, this includes no options unless noted otherwise.*

## Corrected System Performance

The specifications in this section apply for measurements made with the N5227A PNA network analyzer with the following conditions:

- 10 Hz IF bandwidth
- No averaging applied to data
- Isolation calibration with an averaging factor of 8

### System Dynamic Range and Receiver Dynamic Range

- **System Dynamic Range** is defined as the specified source maximum output power (spec) minus the noise floor (spec).
- **Extended Dynamic Range at Direct Access Input** is defined as the specified source maximum output power (spec) minus the direct receiver access input noise floor (spec).
- **Receiver Dynamic Range** is defined as the test port compression at 0.1 dB (typical) minus the noise floor (typical).

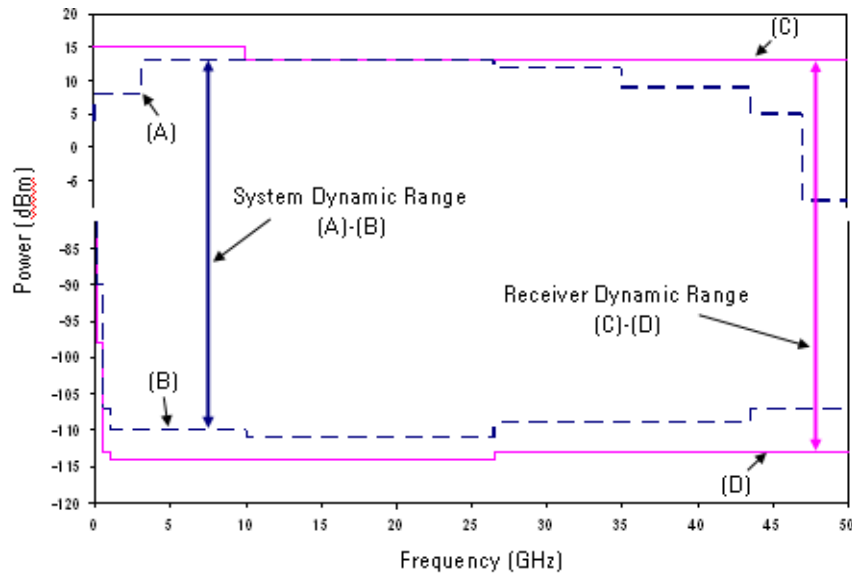

#### NOTE

The effective dynamic range must take measurement uncertainties and interfering signals into account. This set-up should only be used when the receiver input will never exceed its maximum receiver input. When the analyzer is in segment sweep mode, it can have predefined frequency segments which will output a higher power level when the extended dynamic range is required (i.e. devices with high insertion loss), and reduced power when the maximum receiver input level will occur (i.e. devices with low insertion loss). The extended range is only available in one-path transmission measurements.

It may typically be degraded at particular frequencies below 500 MHz due to spurious receiver residuals.

**Table 1. System Dynamic Range and Receiver Dynamic Range, Option 200, 400**

<i>Description</i>	<i>Specification</i>			<i>Typical</i>		
	<i>System Dynamic Range (dB) (A)-(B)</i>	<i>Max Leveled Output Power (dBm) (A)</i>	<i>Test Port Noise Floor (dBm) (B)</i>	<i>Receiver Dynamic Range (dB) (C)-(D)</i>	<i>0.1 dB Compression at Test Port (dBm) (C)</i>	<i>Test Port Noise Floor (dBm) (D)</i>
10 MHz to 50 MHz	82	12	-70	91	15	-76
50 MHz to 100 MHz	105	13	-92	112	15	-97
100 MHz to 500 MHz	114	13	-101	118	12	-106
500 MHz to 1 GHz	123	13	-110	127	12	-115
1 GHz to 10 GHz	127	13	-114	131	12	-119
10 GHz to 13.5 GHz	126	12	-114	132	12	-120
13.5 GHz to 16 GHz	128	12	-116	133	12	-121
16 GHz to 24 GHz	127	11	-116	133	12	-121
24 GHz to 26.5 GHz	128	11	-117	133	12	-121
26.5 GHz to 30 GHz	116	10	-106	124	12	-112
30 GHz to 32 GHz	115	9	-106	123	11	-112
32 GHz to 35 GHz	116	10	-106	123	11	-112
35 GHz to 40 GHz	109	5	-104	121	11	-110
40 GHz to 50 GHz	112	11	-101	119	11	-108
50 GHz to 60 GHz	112	11	-101	118	11	-107
60 GHz to 67 GHz	112	11	-101	119	11	-108
67 GHz to 70 GHz	--	--	--	117	11	-106

**Table 2. System Dynamic Range at Test Port (dB)**

Description	Specification			Typical		
	Option 200, 400	Option 201, 401	Option 219, 419	Option 200, 400	Option 201, 401	Option 219, 419
10 MHz to 50 MHz	82	82	81	96	95	95
50 MHz to 100 MHz	105	105	105	117	117	116
100 MHz to 500 MHz	114	114	114	126	126	125
500 MHz to 1 GHz	123	123	123	136	135	134
1 GHz to 2 GHz	127	127	127	139	139	137
2 GHz to 3.2 GHz	127	127	127	137	136	136
3.2 GHz to 10 GHz	127	127	126	138	138	137
10 GHz to 13.5 GHz	126	125	123	138	137	136
13.5 GHz to 16 GHz	128	128	126	140	139	138
16 GHz to 19 GHz	127	126	124	138	138	135
19 GHz to 20 GHz	127	127	124	138	138	134
20 GHz to 24 GHz	127	127	124	137	137	134
24 GHz to 26.5 GHz	128	128	124	136	136	133
26.5 GHz to 30 GHz	116	116	113	127	127	124
30 GHz to 32 GHz	115	113	111	126	125	123
32 GHz to 35 GHz	116	115	112	127	126	124
35 GHz to 40 GHz	109	109	105	123	122	119
40 GHz to 43.5 GHz	112	111	107	120	120	119
43.5 GHz to 50 GHz	112	111	107	121	120	118
50 GHz to 60 GHz	112	111	106	120	119	117
60 GHz to 64 GHz	112	111	106	121	120	117
64 GHz to 67 GHz	112	111	105	122	121	116
67 GHz to 70 GHz	--	--	--	--	--	110



**Table 3. Extended Dynamic Range at Direct Receiver Access Input (dB) - Specification**

<i>Description</i>	<i>Option 201, 401</i>	<i>Option 219, 419</i>
10 MHz to 50 MHz	--	--
50 MHz to 100 MHz	117	117
100 MHz to 500 MHz	126	126
250 MHz to 500 MHz	126	126
500 MHz to 1 GHz	135	135
1 GHz to 2 GHz	139	139
2 GHz to 3.2 GHz	138	138
3.2 GHz to 10 GHz	138	137
10 GHz to 13.5 GHz	136	134
13.5 GHz to 16 GHz	139	137
16 GHz to 19 GHz	137	135
19 GHz to 24 GHz	138	135
24 GHz to 26.5 GHz	139	135
26.5 GHz to 30 GHz	127	124
30 GHz to 32 GHz	123	121
32 GHz to 35 GHz	125	122
35 GHz to 40 GHz	119	115
40 GHz to 45 GHz	121	117
45 GHz to 50 GHz	120	116
50 GHz to 64 GHz	119	114
64 GHz to 67 GHz	119	113

**N5227A Corrected System Performance, All Options**

For any  $S_{ii}$  reflection measurement:

- $S_{jj} = 0$ .

For any  $S_{ij}$  transmission measurement:

- $S_{ji} = S_{ij}$  when  $S_{ij} \leq 1$
- $S_{ji} = 1/S_{ij}$  when  $S_{ij} > 1$
- $S_{kk} = 0$  for all  $k$

Applies to the N5227A Option 200, 201, 219, 400, 401, or 419 analyzers, N4697F flexible test port cable set, and a full 2-port calibration. Also applies to the following condition:

Environmental temperature  $23^\circ \pm 3^\circ \text{C}$ , with  $< 1^\circ \text{C}$  deviation from calibration temperature

**Table 4a. N5227A with 85058B Calibration Kit**

Description	Specification (dB)							
	10 MHz to 50 MHz	50 MHz to 2 GHz	2 GHz to 10 GHz	10 GHz to 20 GHz	20 GHz to 35 GHz	35 GHz to 50 GHz	50 GHz to 60 GHz	60 GHz to 67 GHz
Directivity	35	35	38	38	37	37	34	34
Source Match	34	34	40	40	41	42	40	40
Load Match	34	35	37	37	36	36	33	33
Reflection Tracking								
Mag	0.019	0.019	0.033	0.033	0.033	0.020	0.030	0.030
Phase (°)	0.125	0.125	0.218	0.218	0.218	0.132	0.198	0.198
Transmission Tracking								
Mag	0.159	0.128	0.099	0.094	0.100	0.093	0.121	0.137
Phase (°)	1.047	0.845	0.655	0.619	0.663	0.616	0.801	0.903

## Transmission Uncertainty, All Options

### Magnitude

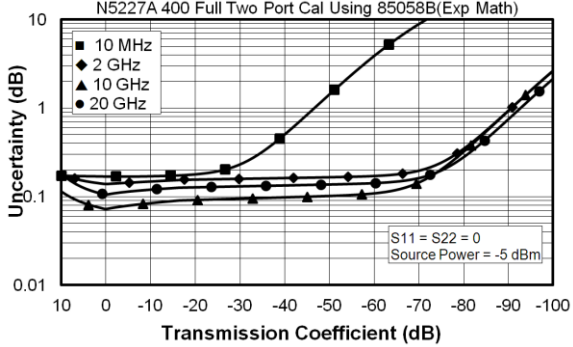

### Phase

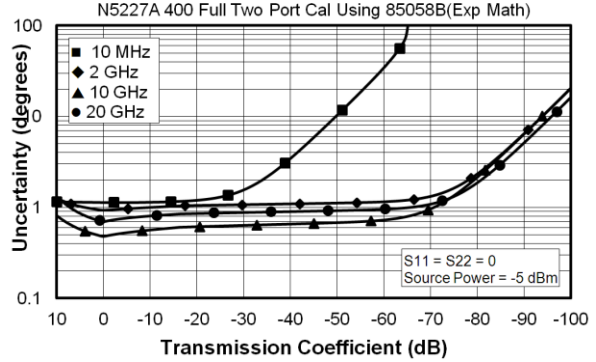

### Magnitude

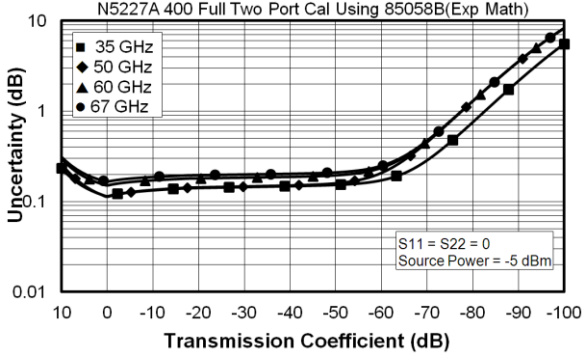

### Phase

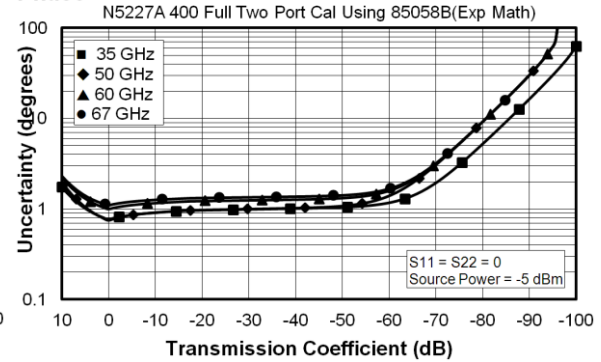

## Reflection Uncertainty, All Options

### Magnitude

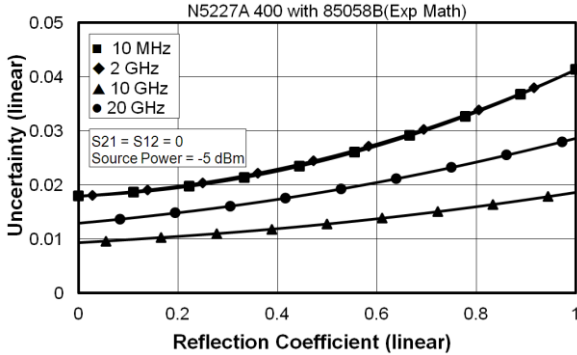

### Phase

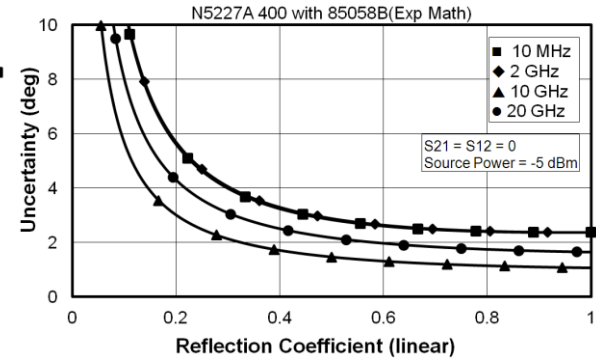

### Magnitude

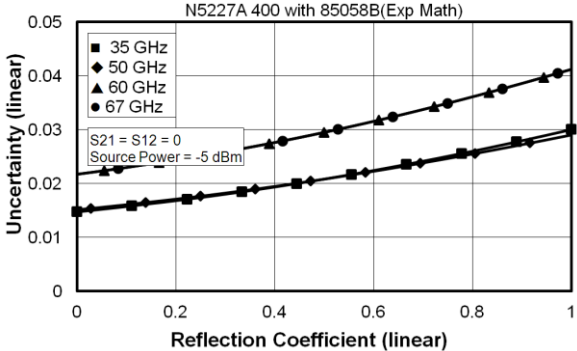

### Phase

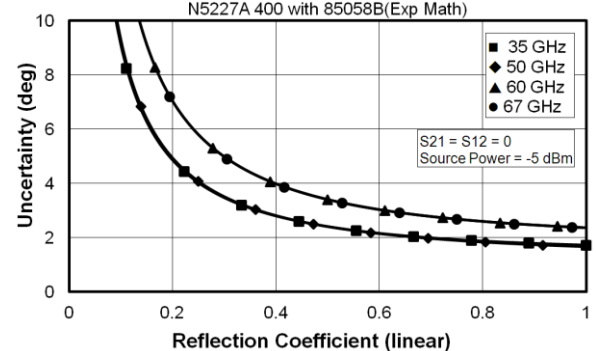
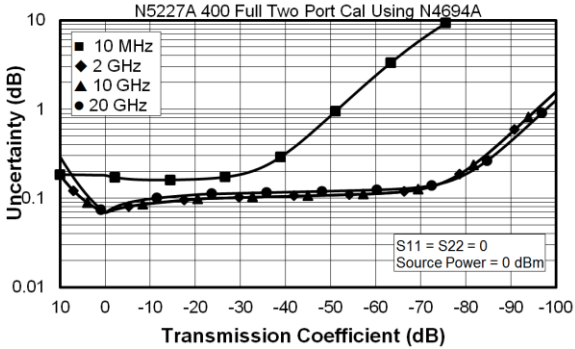

**Table 4b. N5227A with N4694A 2-Port Electronic Calibration Module**

Description	Specification (dB)							
	10 MHz to 50 MHz	50 MHz to 2 GHz	2 GHz to 20 GHz	20 GHz to 30 GHz	30 GHz to 40 GHz	40 GHz to 50 GHz	50 GHz to 60 GHz	60 GHz to 67 GHz
Directivity	33	41	47	46	44	42	41	38
Source Match	25	38	39	35	34	33	30	27
Load Match	25	37	38	34	33	32	29	26
Reflection Tracking Mag	±0.050	±0.040	±0.040	±0.050	±0.060	±0.070	±0.080	±0.090
Phase (°)	±0.330	±0.264	±0.264	±0.330	±0.396	±0.462	±0.528	±0.594
Transmission Tracking Mag	±0.146	±0.059	±0.057	±0.072	±0.087	±0.104	±0.114	±0.144
Phase (°)	±0.966	±0.392	±0.378	±0.473	±0.576	±0.688	±0.754	±0.951

## Transmission Uncertainty, All Options

### Magnitude



### Phase

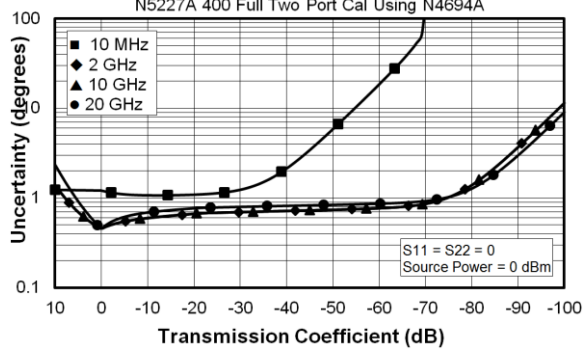

### Magnitude

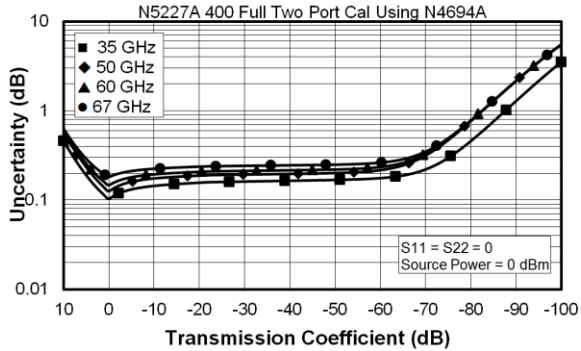

### Phase

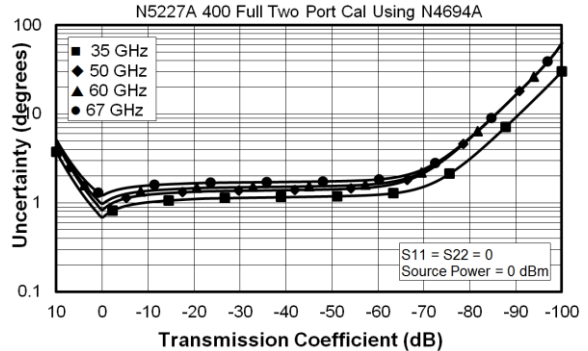

## Reflection Uncertainty, All Options

### Magnitude

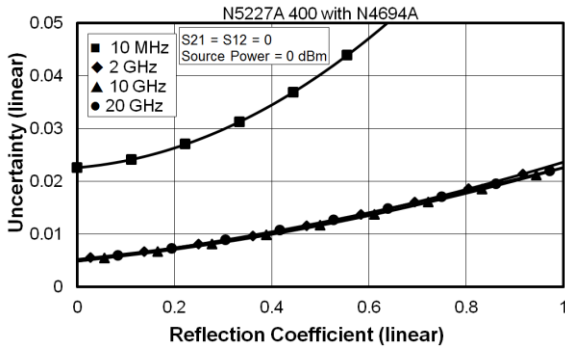

### Phase

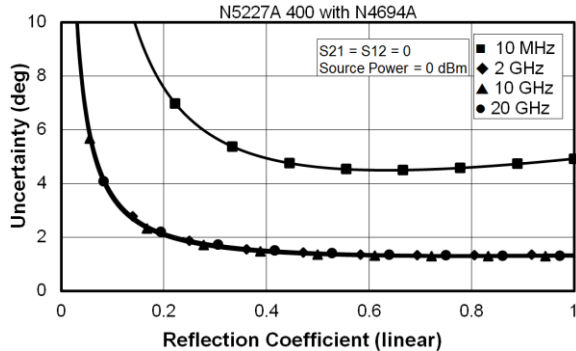

### Magnitude

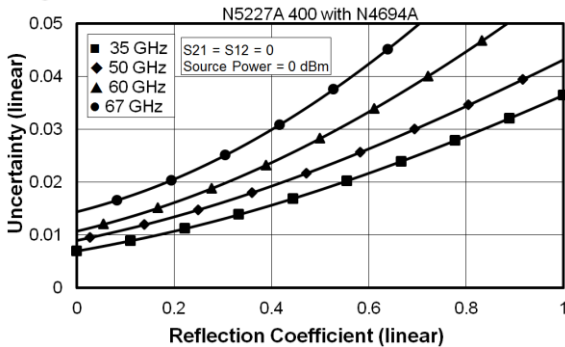

### Phase

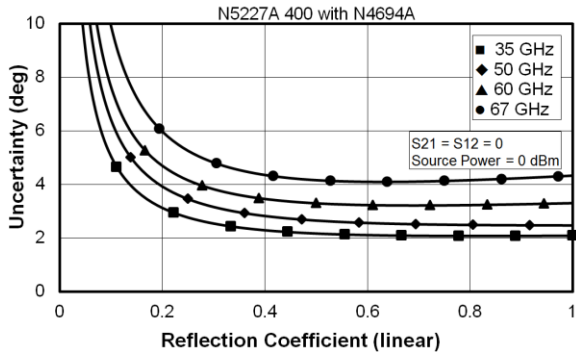

## Uncorrected System Performance

Specifications apply to following conditions:

- Over environmental temperature of 25 °C ±5 °C, with less than 1°C variation from the calibration temperature.
- Cable loss not included in Transmission Tracking.
- Crosstalk measurement conditions: normalized to a thru, measured with shorts on all ports, 10 Hz IF bandwidth, averaging factor of 8, alternate mode, source power set to the specified maximum power.

**Table 5a. Error Terms (dB), All Ports, All Options - Specifications**

	Directivity	Source Match	Load Match	Transmission Tracking	Reflection Tracking	Crosstalk
10 MHz to 50 MHz	17	7	6	--	--	--
50 MHz to 500 MHz	24	15	11	--	--	--
500 MHz to 2 GHz	24	10	7	--	--	--
2 GHz to 3.2 GHz	20	10	7			
3.2 GHz to 10 GHz	20	7	7	--	--	--
10 GHz to 16 GHz	16	7	6	--	--	--
16 GHz to 20 GHz	16	7	7	--	--	--
20 GHz to 26.5 GHz	14	7	7			
26.5 GHz to 50 GHz	13	7	6	--	--	--
50 GHz to 60 GHz	13	7	7	--	--	--
60 GHz to 67 GHz	10	6	6	--	--	--
67 GHz to 70 GHz	--	--	--	--	--	--

**Table 5b. Error Terms (dB), All Ports, All Options - Typical**

	<i>Directivity</i>	<i>Source Match</i>	<i>Load Match</i>	<i>Transmission Tracking</i>	<i>Reflection Tracking</i>	<i>Crosstalk</i>
10 MHz to 50 MHz	20	9	8	+/- 1.0	+/- 1.0	-90
50 MHz to 200 MHz	28	19	17	+/- 1.0	+/- 1.0	-109
200 MHz to 500 MHz	28	19	17	+/- 1.0	+/- 1.0	-123
500 MHz to 2 GHz	31	14	12	+/- 1.0	+/- 1.0	-124
2 GHz to 3.2 GHz	28	14	12	+/- 1.0	+/- 1.0	-124
3.2 GHz to 10 GHz	25	11	10	+/- 1.0	+/- 1.0	-124
10 GHz to 13.5 GHz	23	10	10	+/- 1.0	+/- 1.0	-124
13.5 GHz to 16 GHz	23	11	11	+/- 1.0	+/- 1.0	-124
16 GHz to 20 GHz	20	11	11	+/- 1.0	+/- 1.0	-124
20 GHz to 26.5 GHz	18	11	11	+/- 1.0	+/- 1.0	-124
26.5 GHz to 43.5 GHz	16	11	11	+/- 1.0	+/- 1.0	-115
43.5 GHz to 50 GHz	19	11	11	+/- 1.0	+/- 1.0	-113
50 GHz to 60 GHz	16	11	12	+/- 1.0	+/- 1.0	-113
60 GHz to 67 GHz	16	9	10	+/- 1.0	+/- 1.0	-113
67 GHz to 70 GHz	15	10	10	+/- 1.0	+/- 1.5	-110

## Test Port Output

**Table 6. Frequency Information, All Options**

Description	Specification	Typical
N5227A Frequency Range	10 MHz to 67 GHz	67 GHz to 70 GHz
Frequency Resolution	1 Hz	--
Frequency Accuracy	+/- 1 ppm	--
Frequency Stability	--	+/-0.05 ppm, -10° to 70° C1 +/-0.1 ppm/yr maximum <sup>2</sup>

<sup>1</sup> Assumes no variation in time.

<sup>2</sup> Assumes no variation in temperature.

**Table 7a. Maximum Leveled Power (dBm) - Specification**

Description	Option 200, 400		Option 201, 401		Option 219, 419	
	Port 1, Port 3	Port 2, Port 4	Port 1, Port 3	Port 2, Port 4	Port 1, Port 3	Port 2, Port 4
10 MHz to 50 MHz	10	10	10	10	9	9
50 MHz to 2 GHz	13	13	13	13	13	13
2 GHz to 3.2 GHz	10	13	10	13	9	13
3.2 GHz to 10 GHz	13	13	13	13	11	12
10 GHz to 13.5 GHz	12	12	11	11	9	9
13.5 GHz to 16 GHz	12	12	12	12	10	10
16 GHz to 19 GHz	11	11	10	10	8	8
19 GHz to 24 GHz	11	11	11	11	8	8
24 GHz to 26.5 GHz	11	11	11	11	7	7
26.5 GHz to 30 GHz	10	10	10	10	7	7
30 GHz to 32 GHz	9	9	7	7	5	5
32 GHz to 35 GHz	10	10	9	9	6	6
35 GHz to 40 GHz	5	5	5	5	1	1
40 GHz to 50 GHz	11	11	10	10	6	6
50 GHz to 64 GHz	11	11	10	10	5	5
64 GHz to 67 GHz	11	11	10	10	4	4



**Table 7b. Maximum Leveled Power (dBm) - Typical**

Description	Option 200, 400		Option 201, 401		Option 219, 419	
	Port 1, Port 3	Port 2, Port 4	Port 1, Port 3	Port 2, Port 4	Port 1, Port 3	Port 2, Port 4
10 MHz to 50 MHz	20	17	19	17	19	17
50 MHz to 500 MHz	20	18	20	18	19	17
500 MHz to 1 GHz	20	21	20	20	19	18
1 GHz to 2 GHz	18	20	18	20	17	18
2 GHz to 3.2 GHz	17	18	17	17	15	17
3.2 GHz to 10 GHz	19	19	19	18	18	18
10 GHz to 13.5 GHz	18	16	17	15	16	14
13.5 GHz to 16 GHz	19	18	18	17	17	16
16 GHz to 19 GHz	17	17	17	16	14	14
19 GHz to 20 GHz	17	17	17	16	13	13
20 GHz to 24 GHz	16	16	16	15	12	13
24 GHz to 30 GHz	15	15	15	14	12	12
30 GHz to 32 GHz	14	14	13	13	11	11
32 GHz to 35 GHz	15	15	14	14	12	12
35 GHz to 40 GHz	13	13	12	11	9	9
40 GHz to 43.5 GHz	12	12	11	12	11	10
43.5 GHz to 50 GHz	12	13	11	12	10	10
50 GHz to 60 GHz	12	13	12	12	10	9
60 GHz to 64 GHz	12	13	12	12	9	9
64 GHz to 67 GHz	13	14	13	13	8	8
67 GHz to 70 GHz	13	14	12	12	4	4

**Table 8. Power Level Accuracy (dB) at Nominal Power<sup>1</sup>, All Options**

Description	Specification	Typical
10 MHz to 50 MHz	+/- 1.8	+/- 0.4
50 MHz to 1 GHz	+/- 1.0	+/- 0.4
1 GHz to 3.2 GHz	+/- 1.0	+/- 0.2
3.2 GHz to 20 GHz	+/- 2.0	+/- 0.4
20 GHz to 26.5 GHz	+/- 2.2	+/- 0.4
26.5 GHz to 40 GHz	+/- 3.0	+/- 0.5
40 GHz to 43.5 GHz	+/- 3.0	+/- 0.3
43.5 GHz to 50 GHz	+/- 3.0	+/- 0.5
50 GHz to 60 GHz	+/- 3.5	+/- 0.6
60 GHz to 67 GHz	+/- 4.0	+/- 0.7
67 GHz to 70 GHz	--	+/- 1.0

<sup>1</sup> Level accuracy at power other than nominal power, Power Level Accuracy (dB) at Nominal Power + Power Level Linearity (dB).

**Table 9a. Power Level Linearity<sup>1</sup> (dB), All Options - Specification**

Description	Specification		
	Port 1 or 3 <sup>2</sup> -25dBm ≤ P < -20dBm	Port 1 or 3 <sup>2</sup> -20dBm ≤ P < -15dBm	Port 1 or 3 <sup>2</sup> P ≥ -15dBm
10 MHz to 50 MHz	+/-2.7	+/-1.7	+/-1.5
50 MHz to 67 GHz	+/-1.7	+/-1.5	+/-1.5

<sup>1</sup> Referenced to nominal power.

<sup>2</sup> Either port can be used as the source port.

**Table 9b. Power Level Linearity<sup>1</sup> (dB), All Options - Specification**

Description	Specification		
	Port 2 or 4 <sup>2</sup> -25dBm ≤ P < -20dBm	Port 2 or 4 <sup>2</sup> -20dBm ≤ P < -15dBm	Port 2 or 4 <sup>2</sup> P ≥ -15dBm
10 MHz to 50 MHz	+/-3.5	+/-1.7	+/-1.5
50 MHz to 500 MHz	+/-2.7	+/-1.5	+/-1.5
500 MHz to 3.2 GHz	+/-2.5	+/-1.5	+/-1.5
3.2 GHz to 67 GHz	+/-1.5	+/-1.5	+/-1.5

<sup>1</sup> Referenced to nominal power.

<sup>2</sup> Either port can be used as the source port.

**Table 10a. Power Sweep Range (dB) - Specification**

<i>Description</i>	<i>Option 200, 400</i>		<i>Option 201, 401</i>		<i>Option 219, 419</i>	
	<i>Port 1, Port 3</i>	<i>Port 2, Port 4</i>	<i>Port 1, Port 3</i>	<i>Port 2, Port 4</i>	<i>Port 1, Port 3</i>	<i>Port 2, Port 4</i>
<i>10 MHz to 50 MHz</i>	<i>37</i>	<i>37</i>	<i>37</i>	<i>37</i>	<i>36</i>	<i>36</i>
<i>50 MHz to 2 GHz</i>	<i>38</i>	<i>38</i>	<i>38</i>	<i>38</i>	<i>38</i>	<i>38</i>
<i>2 GHz to 3.2 GHz</i>	<i>35</i>	<i>38</i>	<i>35</i>	<i>38</i>	<i>34</i>	<i>38</i>
<i>3.2 GHz to 10 GHz</i>	<i>38</i>	<i>38</i>	<i>38</i>	<i>38</i>	<i>36</i>	<i>37</i>
<i>10 GHz to 13.5 GHz</i>	<i>37</i>	<i>37</i>	<i>36</i>	<i>36</i>	<i>34</i>	<i>34</i>
<i>13.5 GHz to 16 GHz</i>	<i>37</i>	<i>37</i>	<i>37</i>	<i>37</i>	<i>35</i>	<i>35</i>
<i>16 GHz to 19 GHz</i>	<i>36</i>	<i>36</i>	<i>35</i>	<i>35</i>	<i>33</i>	<i>33</i>
<i>19 GHz to 24 GHz</i>	<i>36</i>	<i>36</i>	<i>36</i>	<i>36</i>	<i>33</i>	<i>33</i>
<i>24 GHz to 26.5 GHz</i>	<i>36</i>	<i>36</i>	<i>36</i>	<i>36</i>	<i>32</i>	<i>32</i>
<i>26.5 GHz to 30 GHz</i>	<i>35</i>	<i>35</i>	<i>35</i>	<i>35</i>	<i>32</i>	<i>32</i>
<i>30 GHz to 32 GHz</i>	<i>34</i>	<i>34</i>	<i>32</i>	<i>32</i>	<i>30</i>	<i>30</i>
<i>32 GHz to 35 GHz</i>	<i>35</i>	<i>35</i>	<i>34</i>	<i>34</i>	<i>31</i>	<i>31</i>
<i>35 GHz to 40 GHz</i>	<i>30</i>	<i>30</i>	<i>30</i>	<i>30</i>	<i>26</i>	<i>26</i>
<i>40 GHz to 50 GHz</i>	<i>36</i>	<i>36</i>	<i>35</i>	<i>35</i>	<i>31</i>	<i>31</i>
<i>50 GHz to 64 GHz</i>	<i>36</i>	<i>36</i>	<i>35</i>	<i>35</i>	<i>30</i>	<i>30</i>
<i>64 GHz to 67 GHz</i>	<i>36</i>	<i>36</i>	<i>35</i>	<i>35</i>	<i>29</i>	<i>29</i>

**Table 10b. Power Sweep Range (dB) - Typical**

Description	Option 200, 400		Option 201, 401		Option 219, 419	
	Port 1, Port 3	Port 2, Port 4	Port 1, Port 3	Port 2, Port 4	Port 1, Port 3	Port 2, Port 4
10 MHz to 50 MHz	47	44	46	44	46	44
50 MHz to 500 MHz	47	45	47	45	46	44
500 MHz to 1 GHz	47	48	47	47	46	45
1 GHz to 2 GHz	45	47	45	47	44	45
2 GHz to 3.2 GHz	44	45	44	44	42	44
3.2 GHz to 10 GHz	46	46	46	45	45	45
10 GHz to 13.5 GHz	45	43	44	42	43	41
13.5 GHz to 16 GHz	46	45	45	44	44	43
16 GHz to 19 GHz	44	44	44	43	41	41
19 GHz to 20 GHz	44	44	44	43	40	40
20 GHz to 24 GHz	43	43	43	42	39	40
24 GHz to 30 GHz	42	42	42	41	39	39
30 GHz to 32 GHz	41	41	40	40	38	38
32 GHz to 35 GHz	42	42	41	41	39	39
35 GHz to 40 GHz	40	40	39	38	36	36
40 GHz to 43.5 GHz	39	39	38	39	38	37
43.5 GHz to 50 GHz	39	40	38	39	37	37
50 GHz to 60 GHz	39	40	39	39	37	36
60 GHz to 64 GHz	39	40	39	39	36	36
64 GHz to 67 GHz	40	41	40	40	35	35
67 GHz to 70 GHz	40	41	39	39	31	31

**Table 11. Nominal (Preset) Power (dBm)**

Description	Option 200, 201, 400, 401	Option 219, 419
Preset Power	0	-5

**Table 12. Power Resolution and Maximum/Minimum Settable Power, All Models and Options**

Description	Specification (dB)	Typical (dBm)
Power Resolution	0.01	--
Maximum Settable Power	--	30
Minimum Settable Power		
Option 200, 201, 400, 401	--	-30
Option 219, 419	--	-80

**Table 13. 2<sup>nd</sup> and 3<sup>rd</sup> Harmonics at Max Specified Power (dBc) All Options - Typical**

Listed frequency is harmonic frequency; test at max specified power

Description	N5227A
20 MHz to 4 GHz	-17
4 GHz to 24 GHz	-20
24 GHz to 27 GHz	-21
27 GHz to 40.5 GHz	-32
40.5 GHz to 67 GHz	-60
67 GHz to 70 GHz	-60

**Table 14. Non-Harmonic Spurs at Nominal Power (dBc), All Options - Typical**

Offset frequency = 30 kHz to 5 MHz

Description	Based on 8kHz offset Frac-N	Based on 100kHz offset Frac-N
10 MHz to 500 MHz	-50	-50
500 MHz to 2 GHz	-60	-42
2 GHz to 4 GHz	-57	-45
4 GHz to 8 GHz	-51	-39
8 GHz to 16 GHz	-45	-33
16 GHz to 32 GHz	-39	-27
32 GHz to 64 GHz	-33	-21
64 GHz to 70 GHz	-27	-15

**Table 15. Phase Noise (dBc/Hz), All Options - Typical**

<i>Description</i>	<i>1 kHz Offset</i>	<i>10 kHz Offset</i>	<i>100 kHz Offset</i>	<i>1 MHz Offset</i>
10 MHz to 50 MHz	-100	-95	-95	-120
50 MHz to 1 GHz	-107	-117	-112	-127
1 GHz to 2 GHz	-101	-111	-106	-121
2 GHz to 4 GHz	-95	-105	-100	-115
4 GHz to 8 GHz	-89	-99	-94	-109
8 GHz to 16 GHz	-83	-93	-88	-103
16 GHz to 32 GHz	-77	-87	-82	-97
32 GHz to 64 GHz	-71	-81	-76	-91
64 GHz to 70 GHz	-65	-75	-70	-85

## Test Port Input

**Table 16. Test Port Noise Floor (dBm) @ 10 Hz IFBW, All Options**

Total average (rms) noise power calculated as the mean value of a linear magnitude trace expressed in dBm.  
May typically be degraded at particular frequencies below 500 MHz due to spurious receiver residuals.

Description	Specification	Typical
10 MHz to 50 MHz	-70	-76
50 MHz to 100 MHz	-92	-97
100 MHz to 500 MHz	-101	-106
500 MHz to 1 GHz	-110	-115
1 GHz to 10 GHz	-114	-119
10 GHz to 13.5 GHz	-114	-120
13.5 GHz to 24 GHz	-116	-121
24 GHz to 26.5 GHz	-117	-121
26.5 GHz to 35 GHz	-106	-112
35 GHz to 40 GHz	-104	-110
40 GHz to 50 GHz	-101	-108
50 GHz to 60 GHz	-101	-107
60 GHz to 67 GHz	-101	-108
67 GHz to 70 GHz	--	-106

**Table 17. Direct Receiver Access Input Noise Floor (dBm)**

Total average (rms) noise power calculated as the mean value of a linear magnitude trace expressed in dBm.

May typically be degraded at particular frequencies below 500 MHz due to spurious receiver residuals.

<i>Description</i>	<i>Specification</i>	<i>Typical</i>
	<i>Options 201, 219, 401, 419</i>	<i>Options 201, 219, 401, 419</i>
10 MHz to 50 MHz	--	-116
50 MHz to 100 MHz	-104	-124
100 MHz to 500 MHz	-113	-133
500 MHz to 1 GHz	-122	-142
1 GHz to 2 GHz	-126	-133
2 GHz to 10 GHz	-125	-133
10 GHz to 13.5 GHz	-125	-134
13.5 GHz to 24 GHz	-127	-135
24 GHz to 26.5 GHz	-128	-135
26.5 GHz to 30 GHz	-117	-126
30 GHz to 35 GHz	-116	-125
35 GHz to 40 GHz	-114	-123
40 GHz to 45 GHz	-111	-120
45 GHz to 50 GHz	-110	-120
50 GHz to 67 GHz	-109	-118
67 GHz to 70 GHz	--	-116



**Table 18a. 0.1 dB Receiver Compression at Test Port (dBm), Option 201, 219, 401, 419 - Typical**

Description	N5227A
10 MHz to 100 MHz	15
100 MHz to 30 GHz	12
30 GHz to 67 GHz	11

**Table 18b. Receiver Compression at Test Port Power - Specification**

Description	Test Port Power (dBm)			Receiver Compression	
	Option 200, 400	Option 201, 401	Option 219, 419	Magnitude (dB)	Phase (degrees)
10 MHz to 500 MHz <sup>1</sup>	--	--	--	--	--
500 MHz to 2 GHz	10	13	13	0.15	1.2
2 GHz to 3.2 GHz	7	12	11	0.15	1.2
3.2 GHz to 10 GHz	10	13	12	0.15	1.2
10 GHz to 13.5 GHz	8	11	9	0.15	1.2
13.5 GHz to 16 GHz	8	12	10	0.15	1.2
16 GHz to 20 GHz	6	11	8	0.15	1.2
20 GHz to 24 GHz	6	11	8	0.15	1.2
24 GHz to 30 GHz	6	10	8	0.15	1.2
30 GHz to 35 GHz	5	9	8	0.15	1.2
35 GHz to 40 GHz	0	8	8	0.15	1.2
40 GHz to 67 GHz	4	10	8	0.15	1.2

<sup>1</sup>Test port receiver compression at specified input levels below 500 MHz due to coupler roll off in this frequency range.

**Table 19. N5227A Trace Noise Magnitude (dB rms)**

Ratioed measurement, nominal power at test port.

Description	Specification	Typical		
	1 kHz IFBW	1 kHz IFBW	100 kHz IFBW	600 kHz IFBW
10 MHz to 50 MHz	0.05	0.0177	0.173	0.416
50 MHz to 100 MHz	0.004	0.0012	0.012	0.029
100 MHz to 500 MHz	0.002	0.0006	0.006	0.014
500 MHz to 1 GHz	0.002	0.0004	0.003	0.006
1 GHz to 26.5 GHz	0.002	0.0005	0.002	0.005
26.5 GHz to 50 GHz	0.003	0.0006	0.005	0.012
50 GHz to 67 GHz	0.003	0.0007	0.006	0.013
67 GHz to 70 GHz	--	0.0010	0.007	0.016

**Table 20. N5227A Trace Noise Phase (deg rms)**

Ratioed measurement, nominal power at test port.

Description	Specification	Typical		
	1 kHz IFBW	1 kHz IFBW	100 kHz IFBW	600 kHz IFBW
10 MHz to 50 MHz	0.400	0.1228	1.205	2.928
50 MHz to 100 MHz	0.020	0.0083	0.080	0.196
100 MHz to 500 MHz	0.020	0.0040	0.037	0.097
500 MHz to 1 GHz	0.020	0.0017	0.015	0.037
1 GHz to 26.5 GHz	0.020	0.0075	0.015	0.031
26.5 GHz to 43.5 GHz	0.030	0.0125	0.040	0.091
43.5 GHz to 50 GHz	0.035	0.0149	0.040	0.092
50 GHz to 67 GHz	0.045	0.0200	0.048	0.110
67 GHz to 70 GHz	--	0.0213	0.050	0.119

**Table 21. Reference Level Magnitude, All Models and Options - Specification**

Description	Magnitude (dB)	Phase (degrees)
Range	+/- 500	+/- 500
Resolution	0.001	0.01

**Table 22. Stability, All Options - Typical**

<i>Description</i>	<i>Magnitude (dB/°C)</i>	<i>Phase (°/°C)</i>
10 MHz to 50 MHz	0.03	0.400
50 MHz to 3.2 GHz	0.01	0.100
3.2 GHz to 20 GHz	0.01	0.200
20 GHz to 32 GHz	0.01	0.300
32 GHz to 35 GHz	0.02	0.400
35 GHz to 50 GHz	0.02	0.400
50 GHz to 67 GHz	0.03	0.600
67 GHz to 70 GHz	0.06	1.200

**Table 23. Damage Input Level, All Options**

<i>Description</i>	<i>RF (dBm)</i>	<i>DC (V)</i>
N5227A	27	40

## Dynamic Accuracy

Dynamic accuracy is verified with the following measurements:

Compression over frequency

IF linearity at a single frequency of 1.998765GHz using a reference level of -20 dBm for an input power range of 0 to -60 dBm. For values below -60 dBm, refer to [VNA Receiver Dynamic Accuracy Specifications and Uncertainties](#).

**Table 24. N5227A Dynamic Accuracy**

### N5227A Dynamic Accuracy, 10 MHz - Specification

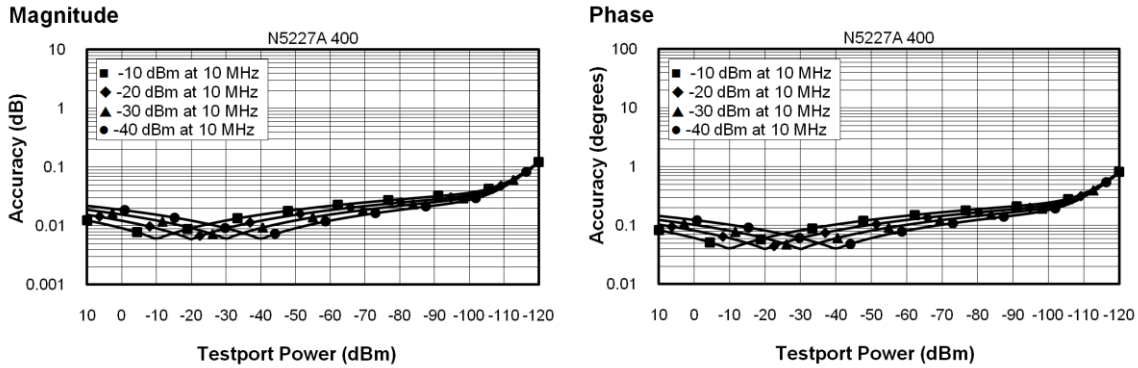

### N5227A Dynamic Accuracy, 50 MHz - Specification

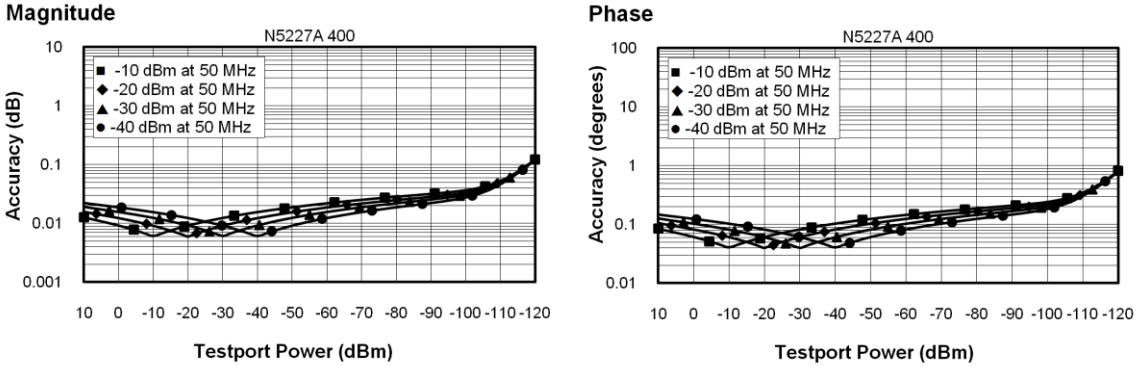

### N5227A Dynamic Accuracy, 500 MHz - Specification

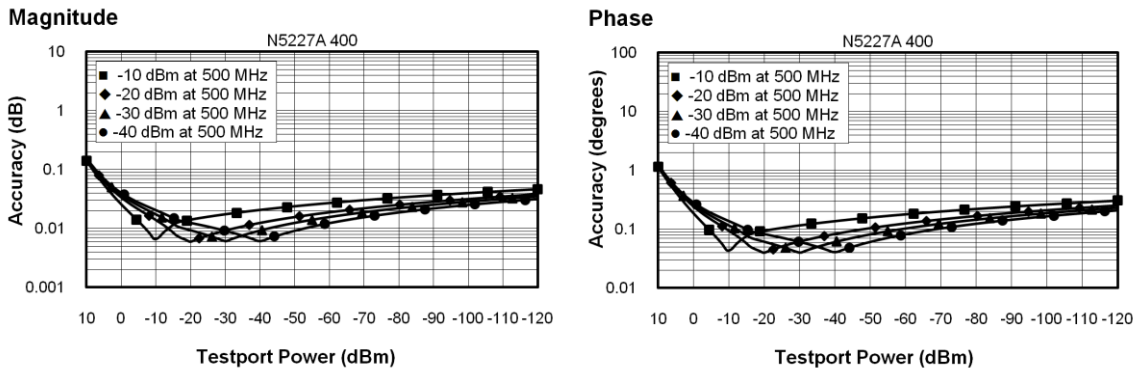

## N5227A Dynamic Accuracy, 1 GHz - Specification

Magnitude

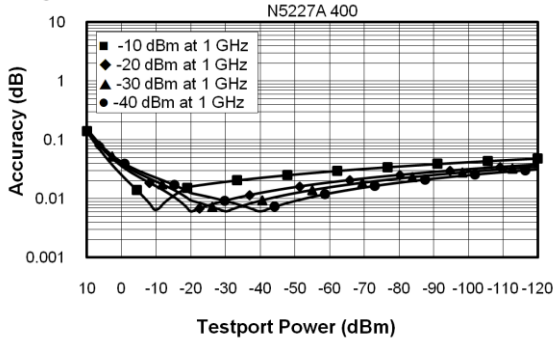

Phase

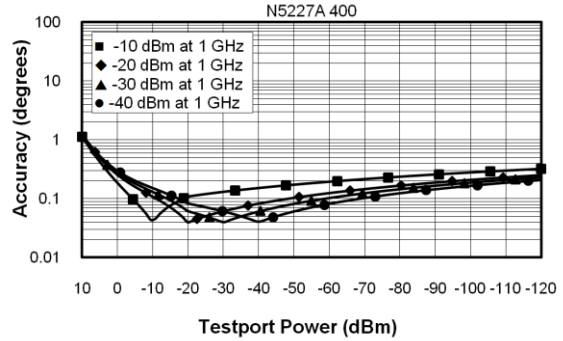

## N5227A Dynamic Accuracy, 2 GHz - Specification

Magnitude

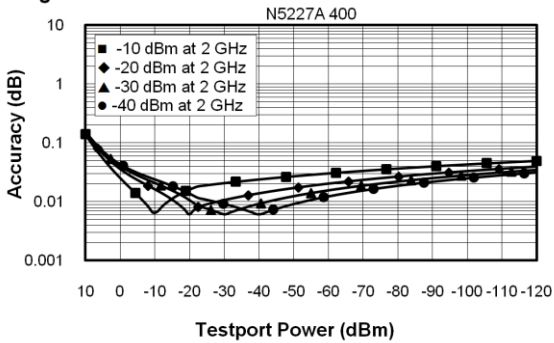

Phase

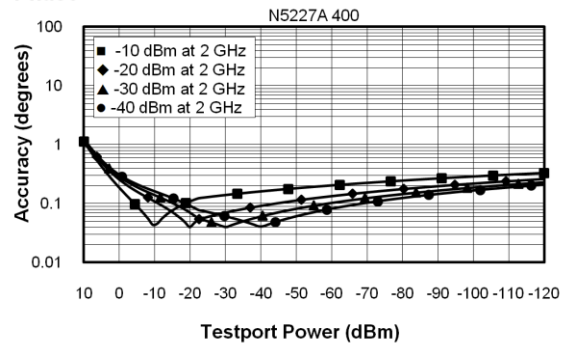

## N5227A Dynamic Accuracy, 20 GHz - Specification

Magnitude

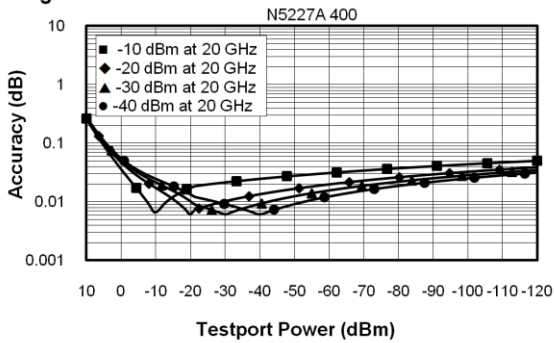

Phase

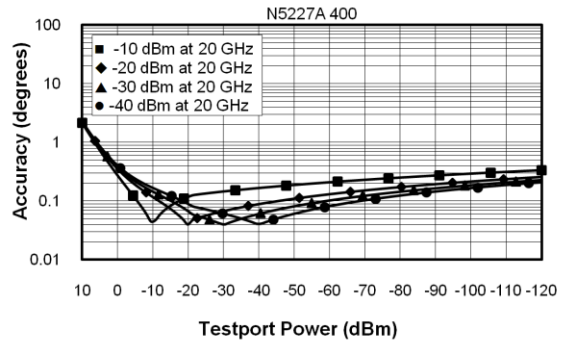

### N5227A Dynamic Accuracy, 26.5 GHz - Specification

Magnitude

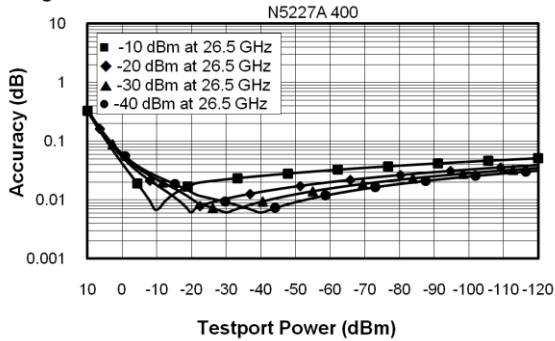

Phase

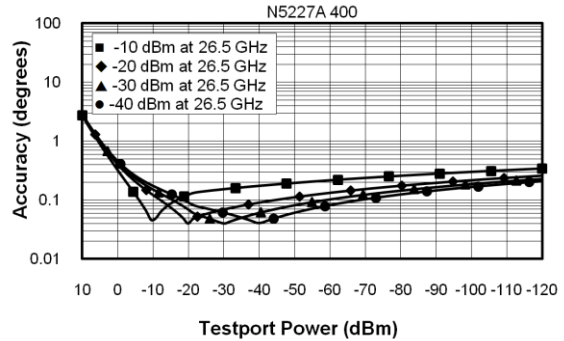

### N5227A Dynamic Accuracy, 35 GHz - Specification

Magnitude

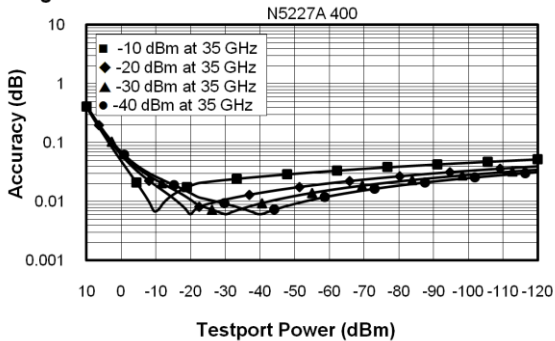

Phase

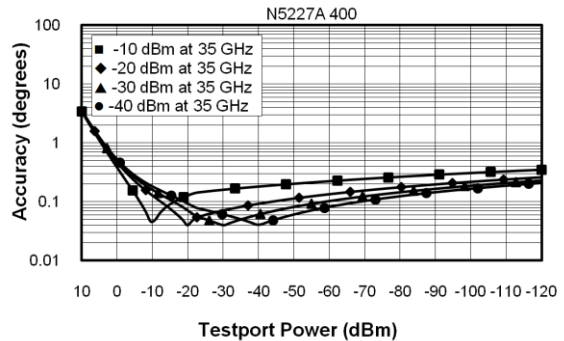

### N5227A Dynamic Accuracy, 40 GHz - Specification

Magnitude

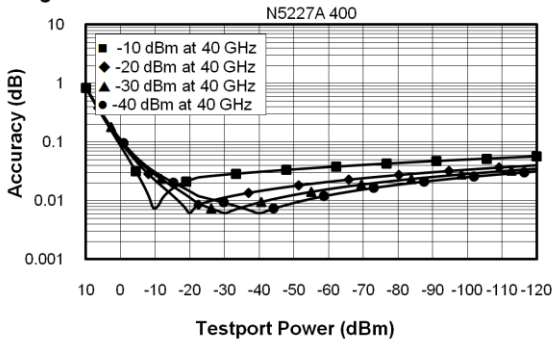

Phase

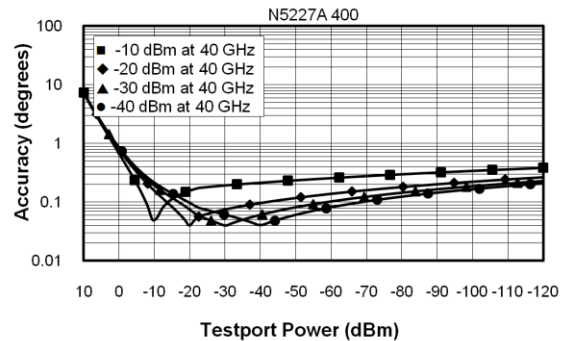

## N5227A Dynamic Accuracy, 50 GHz - Specification

Magnitude

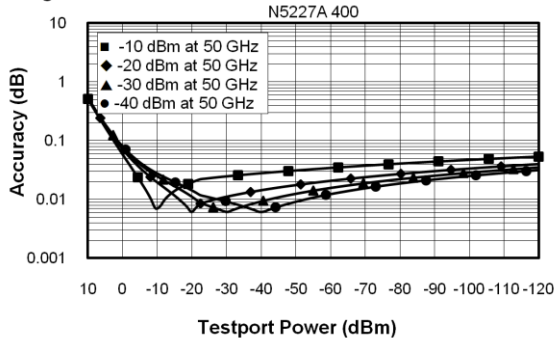

Phase

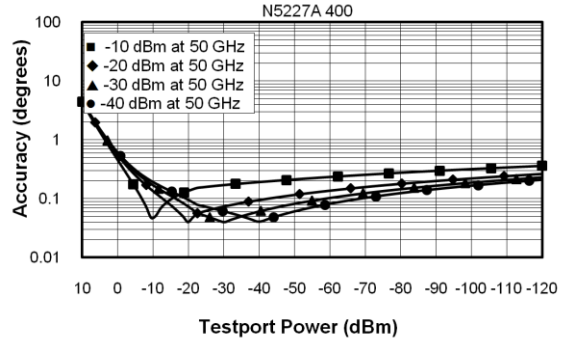

## N5227A Dynamic Accuracy, 60 GHz - Specification

Magnitude

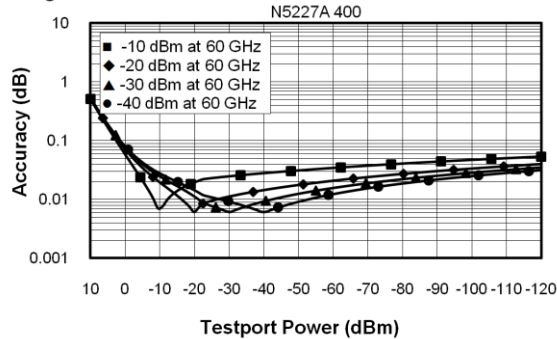

Phase

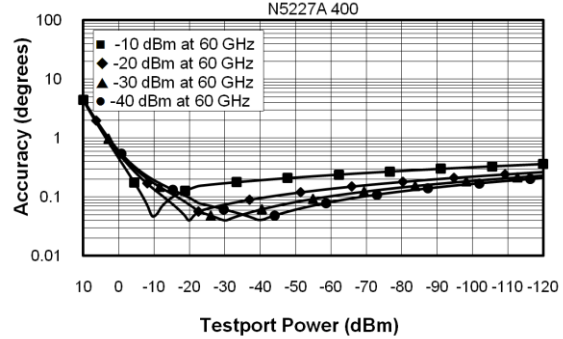

## N5227A Dynamic Accuracy, 67 GHz - Specification

Magnitude

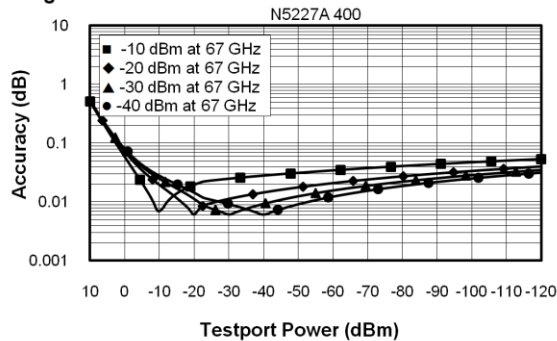

Phase

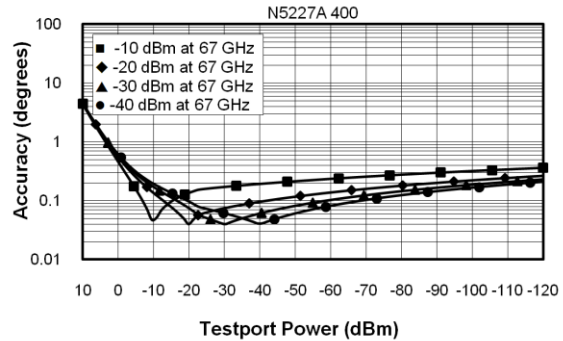

**Table 25. Group Delay - Typical**

Group delay is computed by measuring the phase change within a specified frequency step (determined by the frequency span and the number of points per sweep). In general, the following formula can be used to determine the accuracy, in seconds, of specific group delay measurement:

$$\pm \text{Phase Accuracy (deg)} / [360 \times \text{Aperture (Hz)}]$$

Depending on the aperture and device length, the phase accuracy used is either incremental phase accuracy or worst-case phase accuracy

Description	Typical Performance
Aperture (selectable)	(frequency span)/(number of points - 1)
Maximum Aperture	20% of frequency span
Range	0.5 x (1/minimum aperture)
Maximum Delay	Limited to measuring no more than 180° of phase change within the minimum aperture.)

The following graph shows characteristic group delay accuracy with full 2-port calibration and a 10 Hz IF bandwidth. Insertion loss is assumed to be < 2 dB and electrical length to be ten meters.

For any  $S_{ij}$  Group Delay measurement,  $S_{ii} = 0$ ,  $S_{ij} = 1$ ,  $S_{ji} = 0$ ,  $S_{kl} = 0$  for all  $kl \neq ij$

## Group Delay (Typical)

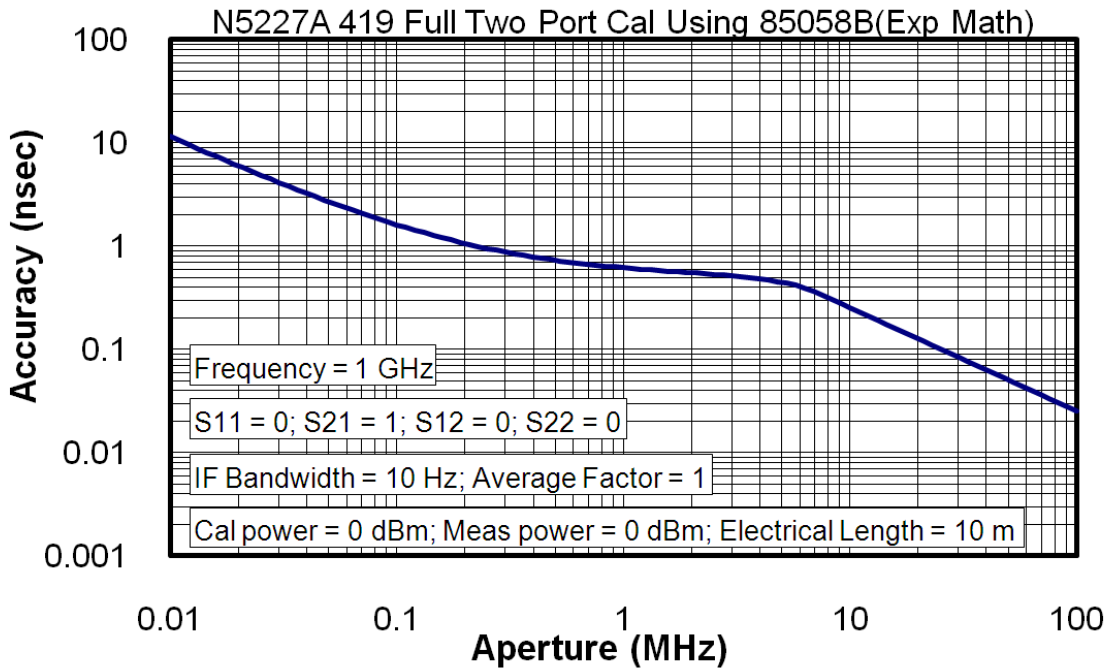



## General Information

- [Miscellaneous Information](#)
- [Front Panel](#)
- [Rear Panel](#)
- [Environment and Dimensions](#)

**Table 26. Miscellaneous Information**

Description	Supplemental Information
System IF Bandwidth Range	1 Hz to 15 MHz, nominal
CPU	For the latest information on CPUs and associated hard drives, visit: <a href="http://na.support.keysight.com/pna/hdnumbers.html">http://na.support.keysight.com/pna/hdnumbers.html</a>
LXI	Class C

**Table 27. Front Panel Information, All Options**

Description	Typical Performance
<b>RF Connectors</b>	
Type	1.85 mm (male), 50 ohm, (nominal)
Center Pin Recession	0.002 in. (characteristic)
<b>USB 2.0 Ports - Master (4 ports)</b>	
Standard	Compatible with USB 2.0
Connector	USB Type-A female
<b>Display</b>	
Size	26.3 cm (10.4 in) diagonal color active matrix LCD; 1024 (horizontal) X 768 (vertical) resolution
Refresh Rate	Vertical 60 Hz; Horizontal 46.08 kHz
Pixels	Any of the following would cause a display to be considered faulty: <ul style="list-style-type: none"> <li>· A complete row or column consists of “stuck” or “dark” pixels.</li> <li>· More than six “stuck on” pixels (but not more than three green) or more than 0.002% of the total pixels are within the LCD specifications.</li> <li>· More than twelve “dark” pixels (but no more than seven of the same color) or more than 0.004% of the total pixels are within the LCD specifications.</li> <li>· Two or more consecutive “stuck on” pixels or three or more consecutive “dark” pixel (but no more than one set of two consecutive dark pixels)</li> <li>· “Stuck on” “dark” pixels are less than 6.5 mm apart (excluding consecutive pixels)</li> </ul>

**Table 27. (Continued) Front Panel Information, All Options**

<i>Description</i>	<i>Typical Performance</i>
<b>Display Range</b>	
<i>Magnitude</i>	+/-2500 dB (at 500 dB/div), max
<i>Phase</i>	+/-2500° (at 500 dB/div), max
<i>Polar</i>	10 pUnits, min 10,000 Units, max
<b>Display Resolution</b>	
<i>Magnitude</i>	0.001 dB/div, min
<i>Phase</i>	0.01°/div, min
<b>Marker Resolution</b>	
<i>Magnitude</i>	0.001 dB, min
<i>Phase</i>	0.01°, min
<i>Polar</i>	10 pUnit, min

**Table 28. Rear Panel Information, All Options**

<i>Description</i>	<i>Typical Performance</i>
<b>10 MHz Reference In</b>	
<i>Connector</i>	BNC, female
<i>Input Frequency</i>	10 MHz ± 10 ppm
<i>Input Level</i>	-15 dBm to +20 dBm
<i>Input Impedance</i>	200 Ω, nom.
<b>10 MHz Reference Out</b>	
<i>Connector</i>	BNC, female
<i>Output Frequency</i>	10 MHz ± 1 ppm
<i>Signal Type</i>	Sine Wave
<i>Output Level</i>	+10 dBm ± 4 dB into 50 Ω
<i>Output Impedance</i>	50 Ω, nominal
<i>Harmonics</i>	<-40 dBc, typical

**Table 28. (Continued) Rear Panel Information, All Options**

<b>Description</b>	<b>Typical Performance</b>
<b>External IF Inputs</b>	
Function	Allows use of external IF signals from remote mixers, bypassing the PNA's first converters
Connectors	SMA (female); A, B, C, D, R (4-port); A, B, R1, R2 (2-port)
Input Frequency	
Normal IF path	RF < 53 MHz: IF = 826.446 KHz RF >= 53 MHz: IF = 7.438 MHz
Narrowband IF path	IF = 10.70 MHz
Input Impedance	50 $\Omega$
RF Damage Level	+23 dBm
DC Damage Level	5.5 VDC
0.1 dB Compression Point	
Normal IF path	-9.0 dBm at 7.438 MHz
Narrowband IF path	-17 dBm at 10.70 MHz
<b>Pulse Inputs (IF Gates)</b>	
Function	Internal receiver gates used for point-in-pulse and pulse-profile measurements
Connectors	15-pin mini D-sub
Input Impedance	1 K Ohm
Minimum Pulse Width, Source Modulators	33 ns
Minimum Pulse Width, Receiver Gates	20 ns
DC Damage Level	5.5 VDC
Drive Voltage	0 V (off), +3.3 V (on), nominal
<b>RF Pulse Modulator Input (Source Modulator)</b>	
<b>On/Off Ratio</b>	
10 MHz to 3.2 GHz	-64
3.2 GHz to 67 GHz	-80
<b>Pulse Period</b>	
Minimum	33 ns
Maximum	70 s

**Table 28. (Continued) Rear Panel Information, All Options**

<i>Description</i>	<i>Typical Performance</i>	
<b>Pulse Outputs</b>		
Voltage (TTL)	High: 3.3V to 3.5V Low: <1V	
Impedance	50 Ohm	
<b>External Test Set Driver</b>		
Function	Used for driving remote mixers	
Connections	3.5 mm (female)	
RF Output Frequency Range	3.2 GHz to 19 GHz	
LO Output Frequency Range	1.76 GHz to 26.5 GHz	
<b>Rear Panel LO Power<sup>1</sup></b>		
	<i>Upper Limit, Typical (dBm)</i>	<i>Lower Limit, Typical (dBm)</i>
1.7 GHz to 16 GHz	5	-3
16 GHz to 21 GHz	0	-6
21 GHz to 26.5 GHz	4	-5
<b>Rear Panel RF1/RF2 Power</b>		
	<i>Maximum Output Power, Typical (dBm)</i>	
3.2 GHz to 5 GHz	+3	
5 GHz to 19 GHz	+8	
<b>Devices Supported</b>		
	<i>Resolutions</i>	
Flat Panel (TFT)	1024 X 768, 800 X 600, 640 X 480	
Flat Panel (DSTN)	800 X 600, 640 X 480	
CRT Monitor	1280 X 1024, 1024 X 768, 800 X 600, 640 X 480	
Simultaneous operation of the internal and external displays is allowed, but with 640 X 480 resolution only. If you change resolution, you can only view the external display (internal display will "white out").		

<sup>1</sup> LO output available in full analyzer's frequency range. The power is tested only from 3.2 GHz to 26.5 GHz.

**Table 28. (Continued) Rear Panel Information, All Options**

<i>Description</i>	<i>Typical Performance</i>
<b><i>Bias Tee Inputs</i></b>	
<i>Connectors</i>	<i>BNC(f) for ports 1, 2, 3 and 4</i>
<i>Fuse</i>	<i>500 mA, bi-pin style</i>
<i>Maximum Bias Current</i>	<i>+/-200 mA with no degradation of RF specifications</i>
<i>Maximum Bias Voltage</i>	<i>+/-40 VDC</i>
<i>Trigger Inputs/Outputs</i>	<i>BNC(f), TTL/CMOS compatible</i>
<i>Test Set IO</i>	<i>25-pin D-Sub connector, available for external test set control.</i>
<i>Power IO</i>	<i>9-pin D-Sub, female; analog and digital IO</i>
<i>Handler IO</i>	<i>36-pin parallel I/O port; all input/output signals are default set to negative logic; can be reset to positive logic via GPIB command.</i>
<i>Pulse I/O</i>	<i>15-pin D connector provides access to Pulse Modulators and Generators</i>
<i>GPIB</i>	<i>Two ports - dedicated controller and dedicated talker/listener. 24-pin D-sub (Type D-24), female; compatible with IEEE-488.</i>
<i>PCIe</i>	<i>Cabled PCIe x4 connector is a 4-lane slot (not currently used)</i>
<i>USB Ports</i>	<i>Two SuperSpeed USB ports (900 mA each), one USB port below LAN connector, and one USB device port. There are also four USB ports (500 mA each) on the front panel. The total current limit for all rear panel USB ports is 2.3 amps. The total current limit for all front panel USB ports is 2 amps.</i>
<i>LAN</i>	<i>10/100/1000 BaseT Ethernet, 8-pin configuration; auto selects between the data rates</i>
<i>VGA Video Output</i>	<i>15-pin mini D-Sub; Drives VGA compatible monitors</i>
<i>Mini DisplayPort</i>	<i>Miniature DisplayPort connector for connection to external displays</i>
<b><i>Line Power</i></b>	
<i>Frequency, Voltage</i>	<i>50/60/400 Hz for 100 to 120 VAC 50/60 Hz for 220 to 240 VAC</i>
	<i>Power supply is auto switching</i>
<i>Max</i>	<i>450 watts</i>

**Table 29. Analyzer Dimensions and Weight**

All models are shipped with handles.

<b>Cabinet Dimensions</b>	<b>Metric (mm)</b>	<b>Imperial (inches)</b>
<b>Height</b>		
Without bottom feet: <sup>1</sup> EIA RU = 6	266.1	10.5
With bottom feet	279.1	11.0
<b>Width</b>		
Without handles or rack-mount flanges	425.6	16.8
With handles, without rack-mount flanges	458.7	18.1
With handles and rack-mount flanges	482.9	19.0
<b>Depth</b>		
Without front and rear panel hardware	582.3	22.9
With front and rear panel hardware, handles	649.6	25.6

<sup>1</sup>Electronics Industry Association rack units. 1 RU = 1.75 in.

See detailed PNA dimension drawings at: <http://na.support.keysight.com/pna/PNADimensions.pdf>

<b>Weight (nominal)</b>	<b>Net</b>	<b>Shipping</b>
2-port models (Option 200, 201, 219)	42.2 kg (93 lb)	57.6 kg (127 lb)
4-port models (Option 400, 401, 419)	44.9 kg (99 lb)	60.3 kg (133 lb)

### **Regulatory and Environmental Information**

For Regulatory and Environmental information, refer to the PNA Series Installation and Quick Start Guide, located online at <http://literature.cdn.keysight.com/litweb/pdf/E8356-90001.pdf>.

## Measurement Throughput Summary

- Typical Cycle Time for Measurement Completion
- Cycle Time vs. IF Bandwidth
- Cycle Time vs. Number of Points
- Data Transfer Time

Cycle time Includes sweep time, retrace time and band-crossing time. Analyzer display turned off with DISPLAY:ENABLE OFF. Add 21 ms for display on. Data for one trace (S<sub>11</sub>) measurement.

**Table 30. Typical Cycle Time (ms) for Measurement Completion, All Models and Options**

Sweep Range	IF Bandwidth		Number of Points				
			201	401	1601	16001	32001
9 GHz to 10 GHz	600 kHz	Uncorrected	6.3	7	10.9	69.5	135
		2-Port cal	18.8	20.3	30.5	152	291
	10 kHz	Uncorrected	28.1	54.7	205	2003	4006
		2-Port cal	67.2	117	418	4028	8062
	1 kHz	Uncorrected	225	444	1744	17041	33853
		2-Port cal	463	900	3500	34100	67744
10 GHz to 20 GHz	600 kHz	Uncorrected	19.5	20.3	25.8	79.7	141
		2-Port cal	46.9	49.2	60.2	174	310
	10 kHz	Uncorrected	69.5	128	259	2012	4012
		2-Port cal	146	264	528	4041	8072
	1 kHz	Uncorrected	235	459	1783	17384	34538
		2-Port cal	477	924	3575	34788	69103

**Table 31. Typical Cycle Time (ms) for Full-Span Measurement Completion**

10 MHz to 67 GHz		Number of Points				
IF Bandwidth		201	401	1601	16001	32001
600 kHz	Uncorrected	55.5	72.7	94.5	182	248
	2-Port cal	117	152	195	374	509
10 kHz	Uncorrected	89.1	153	519	2219	4223
	2-Port cal	185	313	1042	4448	8462
1 kHz	Uncorrected	255	483	1834	17716	35172
	2-Port cal	515	972	3675	35444	70375

**Table 32. Cycle Time vs. IF Bandwidth - Typical**

Applies to the Preset condition (201 points, correction off) except for the following changes:

- CF = 10 GHz
- Span = 100 MHz
- Display off (add 21 ms for display on)

Cycle time includes sweep and retrace time.

Description		N5227A
IF Bandwidth (Hz)	Cycle Time (ms)	Trace Noise Magnitude (dB rms)
600,000	6.3	0.0044
100,000	7	0.0021
30,000	10.2	0.0011
10,000	29.7	0.0007
3,000	71.9	0.0006
1,000	223	0.0004
300	641	0.0004
100	1825	0.0003
30	5981	0.0003
10	17834	0.0003
3	59273	0.0003



**Table 33. Cycle Time vs. Number of Points - Typical**

Applies to the Preset condition (correction off) except for the following changes:

- CF = 10 GHz
- Span = 100 MHz
- Display off (add 21 ms for display on)

Cycle time includes sweep and retrace time.

Description	IF Bandwidth (Hz)			
	1,000	10,000	30,000	600,000
3	7.8	6.3	6.3	6.3
11	16.4	6.3	6.3	6.3
51	60	11	6.3	6.3
101	114	17.2	7	6.3
201	223	29.7	9.4	6.3
401	437	54.7	14.9	7.1
801	862	105	25	7.8
1,601	1708	205	46	11
6,401	6728	805	169	30.5
16,001	16672	2005	417	68.8
32,001	33112	4006	833	134

**Table 34. Data Transfer Time (ms) - Typical**

Measured with the analyzer display off.

Values will increase slightly if the analyzer display is on.

Description	Number of Points				
	201	401	1601	16,001	32,001
<b>SCPI over GPIB</b> (Program executed on external PC <sup>2</sup> )					
32-bit floating point	4.6	9.3	38	352	720
64-bit floating point	9.4	18.8	73.4	730	1455
ASCII	36.7	72.5	288	2882	5762
<b>SCPI over SICL/LAN or TCP/IP Socket<sup>1</sup></b> (Program executed in the analyzer)					
32-bit floating point	<1	<1	<1	1.2	2.4
64-bit floating point	<1	<1	<1	2.3	4.6
ASCII	2.1	4	15	148	295
<b>COM<sup>1</sup></b> (Program executed in the analyzer)					
32-bit floating point	<1	<1	<1	<1	<1
Variant type	<1	<1	1.4	12.4	25.5
<b>DCOM over LAN<sup>1</sup></b> (Program executed on external PC)					
32-bit floating point	<1	<1	<1	2.3	4.4
Variant type	<1	1.6	5.3	52	105.5

<sup>1</sup> Values are for real and imaginary pairs, with the analyzer display off, using Gigabit Ethernet.

**NOTE**

Specifications for Recall & Sweep Speed are not provided for the N522xA analyzers.

## Specifications: Front-Panel Jumpers



The following options have front-panel jumpers for each port:  
201, 219, 401, 419

- Measurement Receiver Inputs
- Port 1 Reference Receiver Inputs and Reference Source Outputs
- Port 2, 3, 4 Reference Receiver Inputs and Reference Source Outputs
- Source Outputs
- Coupler Inputs
- Damage Level

**Table 35. Measurement Receiver Inputs (dBm) - Typical**

(RCVR A, B, C, D IN) @ 0.1dB Typical Compression

Description	N5227A
10 MHz to 500 MHz	-3
500 MHz to 3.2 GHz	-4
3.2 GHz to 26.5 GHz	-5
26.5 GHz to 50 GHz	-4
50 GHz to 64 GHz	-3
64 GHz to 67 GHz	-4
67 GHz to 70 GHz	-2

**Table 36. Port 1 Reference Receiver Inputs and Reference Source Outputs (dBm) - Typical***(RCVR R1 IN, REF 1 SOURCE OUT) @ Max Specified Output Power*

<i>Description</i>	<i>Option 201, 401</i>	<i>Option 219, 419</i>
<i>10 MHz to 50 MHz</i>	<i>-30</i>	<i>-30</i>
<i>50 MHz to 500 MHz</i>	<i>-16</i>	<i>-16</i>
<i>500 MHz to 1 GHz</i>	<i>-9</i>	<i>-9</i>
<i>1 GHz to 2 GHz</i>	<i>-6</i>	<i>-5</i>
<i>2 GHz to 3.2 GHz</i>	<i>-10</i>	<i>-11</i>
<i>3.2 GHz to 10 GHz</i>	<i>-8</i>	<i>-9</i>
<i>10 GHz to 16 GHz</i>	<i>-10</i>	<i>-11</i>
<i>16 GHz to 26.5 GHz</i>	<i>-11</i>	<i>-12</i>
<i>26.5 GHz to 30 GHz</i>	<i>-13</i>	<i>-14</i>
<i>30 GHz to 32 GHz</i>	<i>-16</i>	<i>-16</i>
<i>32 GHz to 35 GHz</i>	<i>-14</i>	<i>-15</i>
<i>35 GHz to 40 GHz</i>	<i>-17</i>	<i>-14</i>
<i>40 GHz to 70 GHz</i>	<i>-12</i>	<i>-14</i>

**Table 37. Port 2, 3, 4 Reference Receiver Inputs and Reference Source Outputs (dBm) - Typical**  
 (RCVR R2 IN, RCVR R3 IN, RCVR R4 IN, REF 2 SOURCE OUT, REF 3 SOURCE OUT, REF 4 SOURCE OUT) @ Max Specified Output Power

Description	Option 201, 401	Option 401	Option 219, 419	Option 419
	RCVR R2 IN, RCVR R4 IN, REF 2 SOURCE OUT, REF 4 SOURCE OUT	RCVR R3 IN, REF 3 SOURCE OUT	RCVR R2 IN, RCVR R4 IN, REF 2 SOURCE OUT, REF 4 SOURCE OUT	RCVR R3 IN, REF 3 SOURCE OUT
10 MHz to 50 MHz	-25	-25	-25	-25
50 MHz to 500 MHz	-6	-6	-10	-10
500 MHz to 1 GHz	-4	-4	-4	-4
1 GHz to 2 GHz	-1	-1	-1	-1
2 GHz to 3.2 GHz	-5	-1	-6	-1
3.2 GHz to 10 GHz	-1	-1	-2	-2
10 GHz to 16 GHz	-3	-3	-4	-4
16 GHz to 26.5 GHz	-4	-4	-4	-4
26.5 GHz to 30 GHz	-4	-4	-5	-5
30 GHz to 32 GHz	-6	-6	-7	-7
32 GHz to 35 GHz	-4	-4	-5	-5
35 GHz to 40 GHz	-8	-8	-9	-9
40 GHz to 50 GHz	-2	-2	-4	-4
50 GHz to 60 GHz	-1	-1	-3	-3
60 GHz to 64 GHz	0	0	-2	-2
64 GHz to 67 GHz	1	1	-3	-3
67 GHz to 70 GHz	0	0	-1	-1

**Table 38. Source Outputs (dBm) - Typical***(PORT 1 SOURCE OUT, PORT 2 SOURCE OUT, PORT 3 SOURCE OUT, PORT 4 SOURCE OUT) @ Max Specified Output Power*

<i>Description</i>	<i>Option 201, 401</i>		<i>Option 219, 419</i>	
	<i>PORT 1 SOURCE OUT</i>	<i>PORT 2 SOURCE OUT</i>	<i>PORT 1 SOURCE OUT</i>	<i>PORT 2 SOURCE OUT</i>
	<i>PORT 3 SOURCE OUT</i>	<i>PORT 4 SOURCE OUT</i>	<i>PORT 3 SOURCE OUT</i>	<i>PORT 4 SOURCE OUT</i>
<i>10 MHz to 50 MHz</i>	<i>12</i>	<i>12</i>	<i>11</i>	<i>11</i>
<i>50 MHz to 1 GHz</i>	<i>13</i>	<i>13</i>	<i>13</i>	<i>13</i>
<i>1 GHz to 2 GHz</i>	<i>14</i>	<i>14</i>	<i>14</i>	<i>14</i>
<i>2 GHz to 3.2 GHz</i>	<i>11</i>	<i>14</i>	<i>10</i>	<i>14</i>
<i>3.2 GHz to 10 GHz</i>	<i>14</i>	<i>14</i>	<i>12</i>	<i>13</i>
<i>10 GHz to 16 GHz</i>	<i>13</i>	<i>13</i>	<i>11</i>	<i>11</i>
<i>16 GHz to 26.5 GHz</i>	<i>13</i>	<i>13</i>	<i>10</i>	<i>10</i>
<i>26.5 GHz to 30 GHz</i>	<i>12</i>	<i>12</i>	<i>10</i>	<i>10</i>
<i>30 GHz to 32 GHz</i>	<i>9</i>	<i>9</i>	<i>8</i>	<i>8</i>
<i>32 GHz to 35 GHz</i>	<i>11</i>	<i>11</i>	<i>9</i>	<i>9</i>
<i>35 GHz to 40 GHz</i>	<i>7</i>	<i>7</i>	<i>5</i>	<i>5</i>
<i>40 GHz to 60 GHz</i>	<i>13</i>	<i>13</i>	<i>12</i>	<i>12</i>
<i>60 GHz to 64 GHz</i>	<i>14</i>	<i>14</i>	<i>13</i>	<i>13</i>
<i>64 GHz to 70 GHz</i>	<i>14</i>	<i>14</i>	<i>12</i>	<i>12</i>

**Table 39. Coupler Inputs (dB) - Typical***(PORT 1, 2, 3, 4 CPLR THRU) Insertion Loss of Coupler Thru*

<i>Description</i>	<i>Option 201, 401</i>	<i>Option 219, 419</i>
10 MHz to 50 MHz	0	0
50 MHz to 500 MHz	-0.25	-0.25
500 MHz to 1 GHz	-0.5	-0.5
1 GHz to 2 GHz	-0.5	-1.0
2 GHz to 3.2 GHz	-0.75	-1.0
3.2 GHz to 10 GHz	-1.0	-1.5
10 GHz to 16 GHz	-1.2	-2.0
16 GHz to 26.5 GHz	-1.8	-2.5
26.5 GHz to 35 GHz	-2.0	-3.0
35 GHz to 40 GHz	-2.5	-4.0
40 GHz to 50 GHz	-3.0	-6.0
50 GHz to 60 GHz	-3.6	-7.2
60 GHz to 64 GHz	-3.8	-7.7
64 GHz to 67 GHz	-4.0	-8.0
67 GHz to 70 GHz	-4.2	-8.4

**Table 40 Damage Level, All Options - Typical**

<i>Description</i>	<i>RF (dBm)</i>	<i>DC (V)</i>
RCVR A, B, C, D IN	15	7
RCVR R1, R2, R3, R4 IN	15	7
REF 1 SOURCE OUT	15	7
REF 2, 3, 4 SOURCE OUT	30	7
PORT 1, 2, 3, 4 SOURCE OUT	27	7
PORT 1, 2, 3, 4 CPLR THRU	27	40
PORT 1, 2, 3, 4 CPLR ARM	30	7

## Test Set Block Diagrams

**NOTE**

For best readability, use a color printer for printing the following graphics.

### Legend

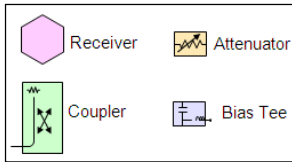

### N5227A Option 200 (2-port base model)

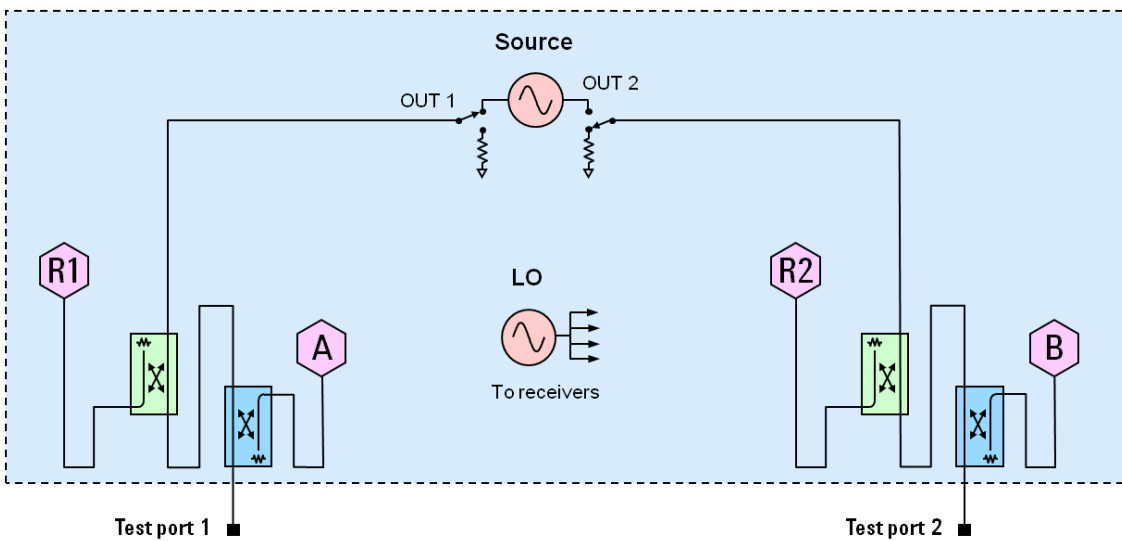

### N5227A Option 201

To base model, adds front-panel jumpers and R1 receiver switch

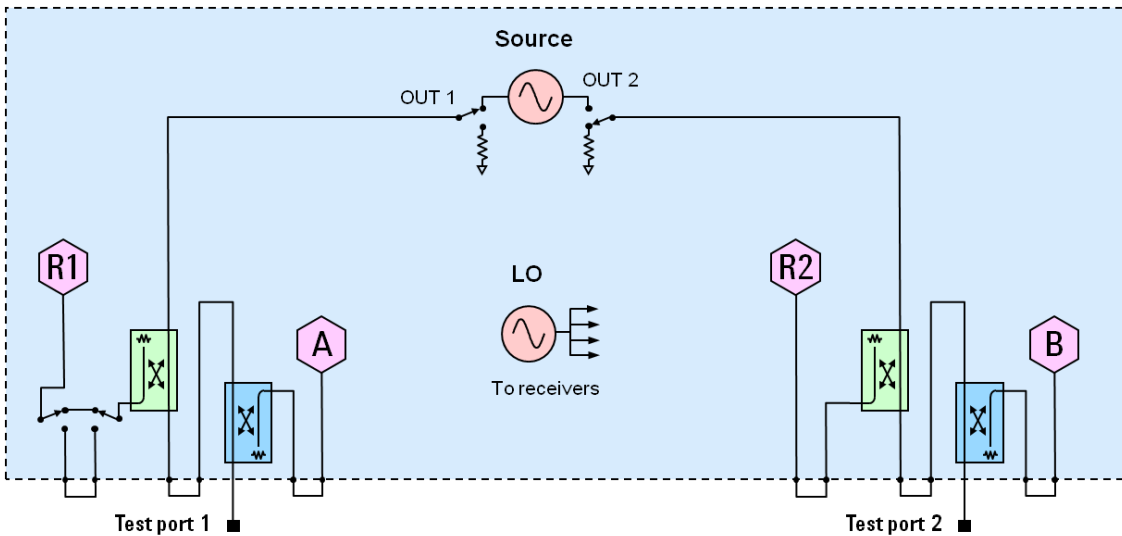



### N5227A Option 219

To base model, adds front-panel jumpers, R1 receiver switch, source and receiver attenuators (extended power range), and bias-tees.

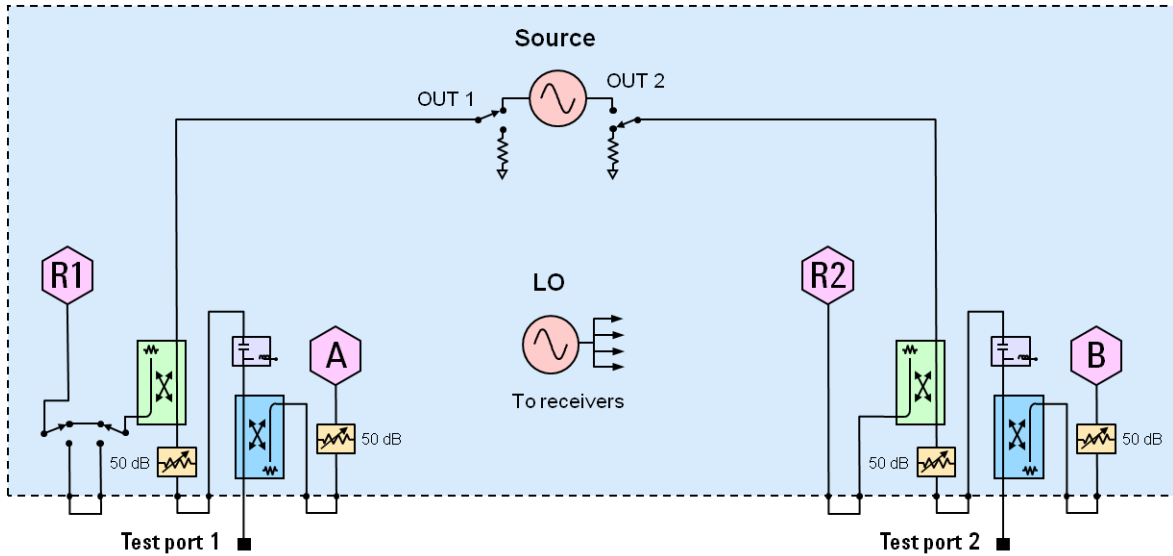

### N5227A Option 400 (4-port base model)

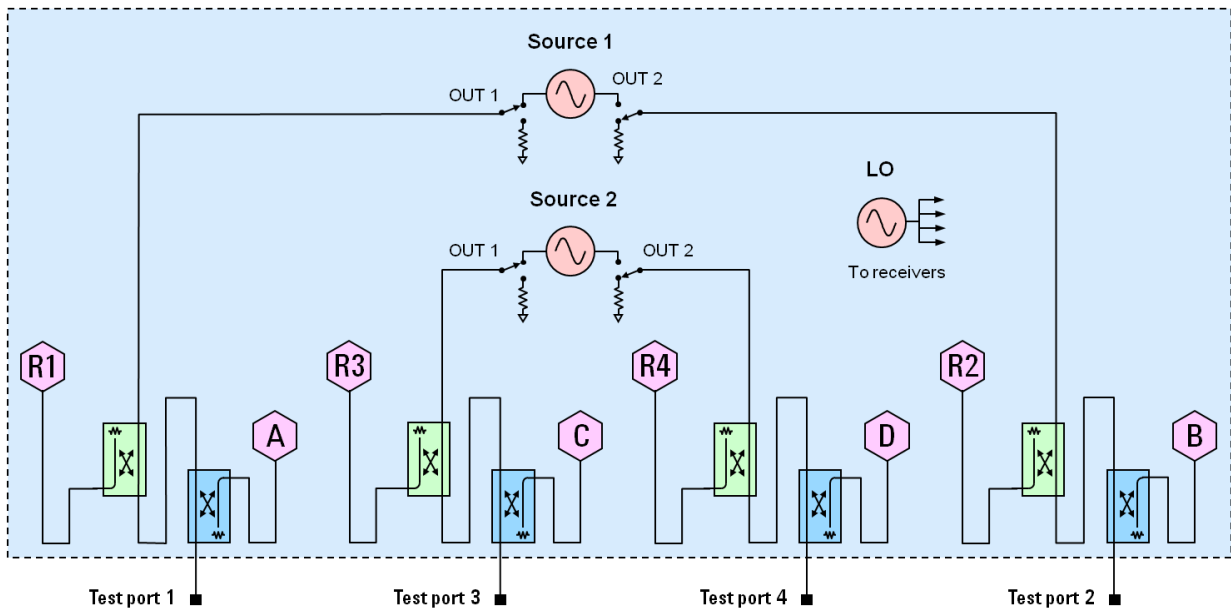

### N5227A Option 401

To base model, adds front-panel jumpers and R1 receiver switch

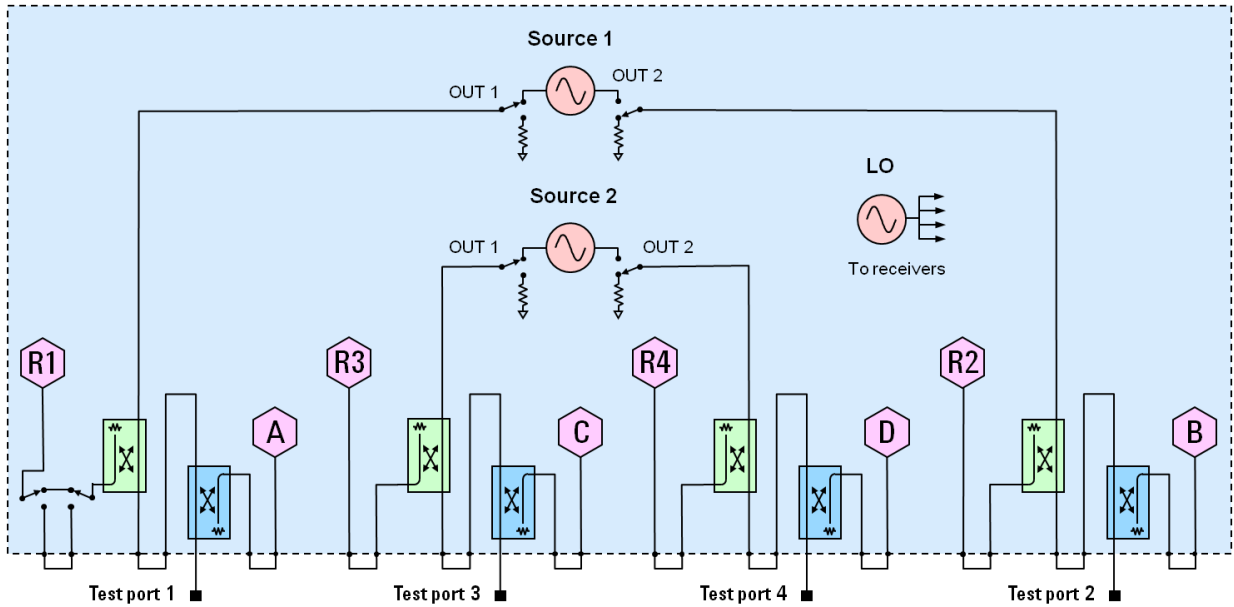

### N5227A Option 419

To base model, adds front-panel jumpers, R1 receiver switch, source and receiver attenuators (extended power range), and bias-tees.

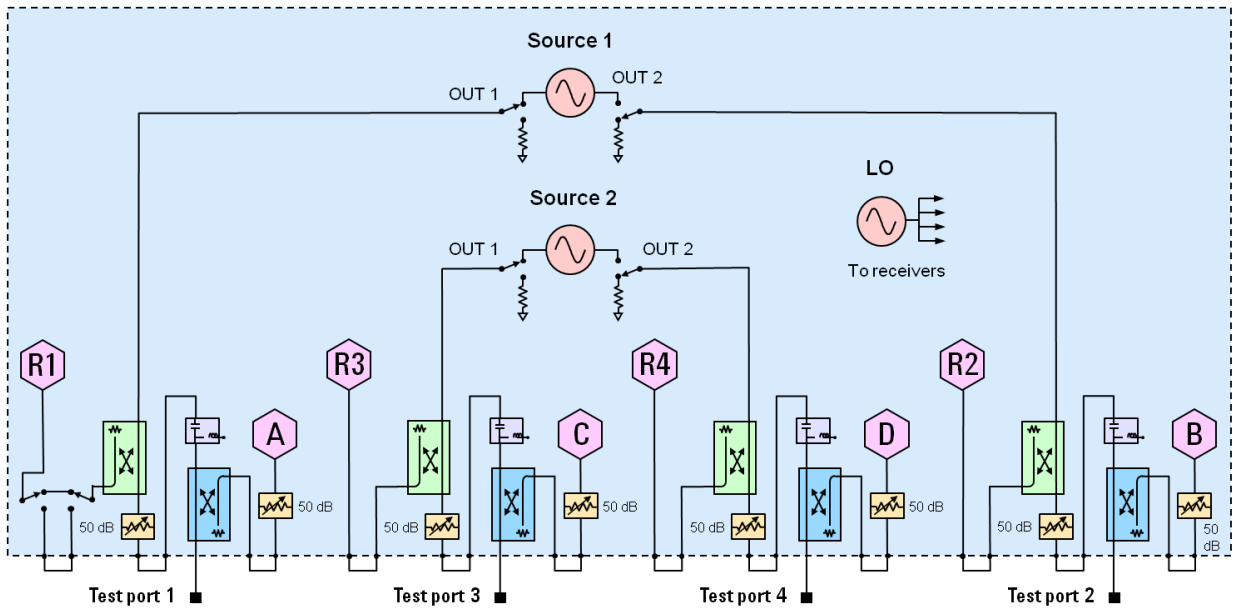

**Receiver Block Diagram**

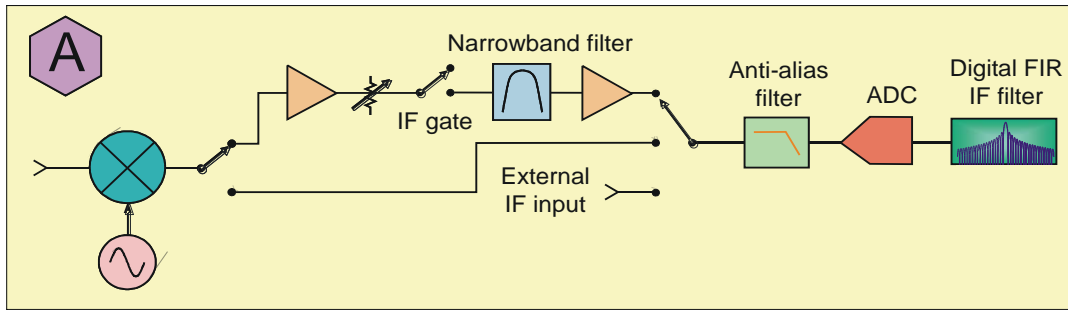



*This information is subject to change without notice.  
© Keysight Technologies 2014-2016  
Print Date: November 7, 2016*



**N5227-90002**

[www.keysight.com](http://www.keysight.com)